

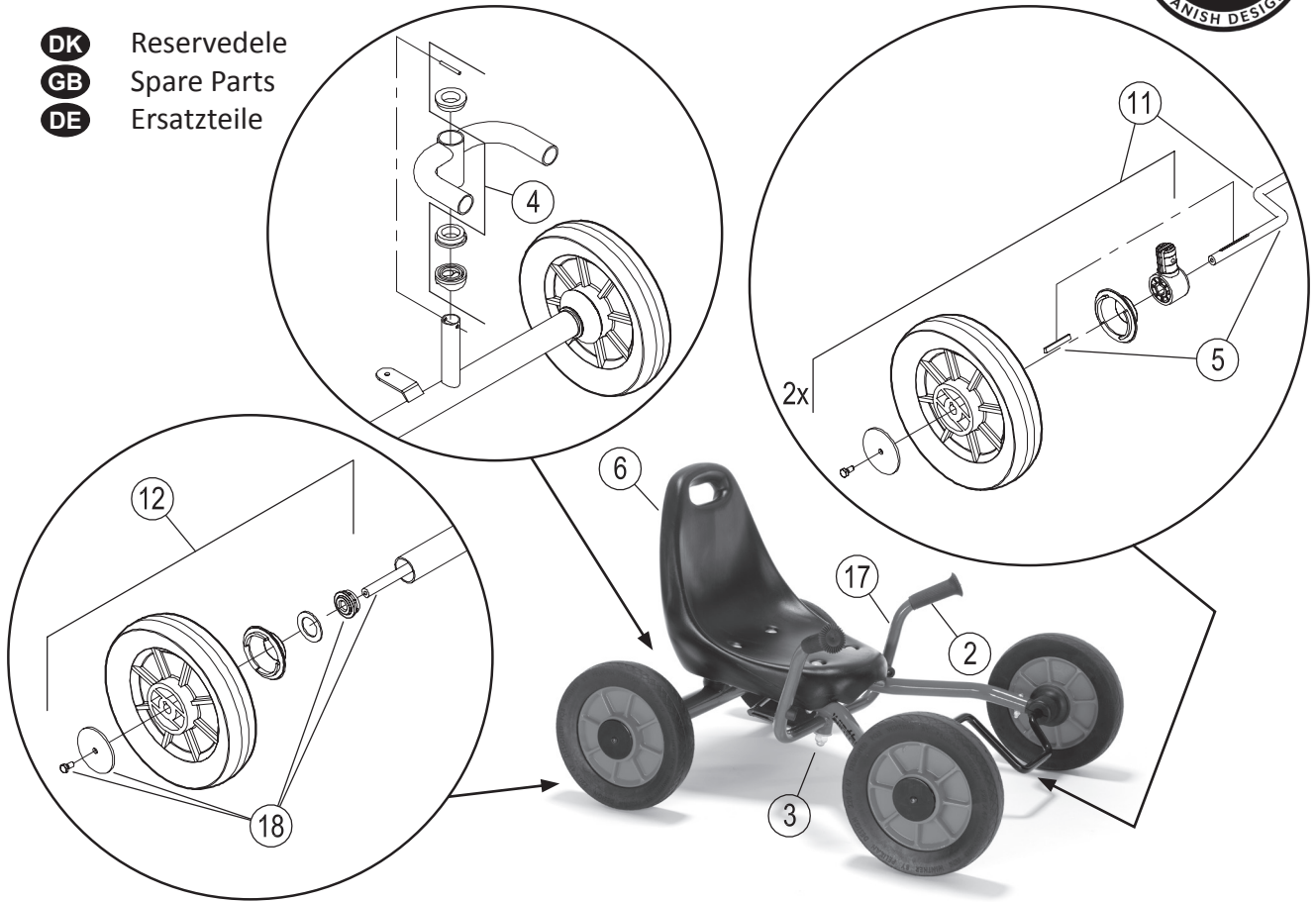





- DK** Reservedele
- GB** Spare Parts
- DE** Ersatzteile



| Pos. | | Pos. | | Pos. | |
|------|--|------|---|------|---|
| 1 |  | 7 | | 13 | |
| 2 |  x2 | 8 | | 14 | |
| 3 |  x2 | 9 | | 15 | |
| 4 |  x2  x1  x1 | 10 | | 16 | |
| 5 |  | 11 |  x2 | 17 |  |
| 6 |  | 12 |  x2 | 18 |  |

- DK** Reservedele
- GB** Spare Parts
- DE** Ersatzteile

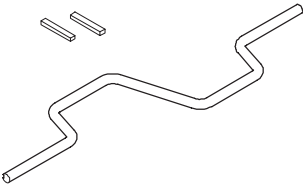
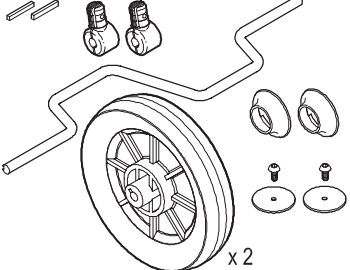
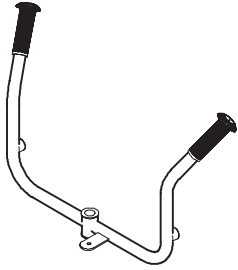
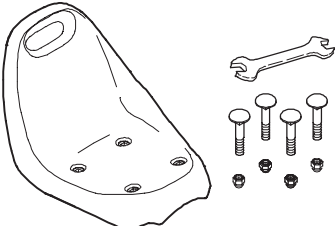
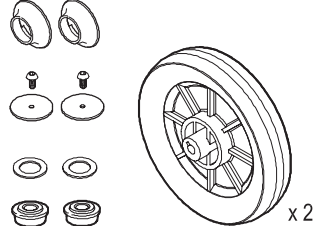
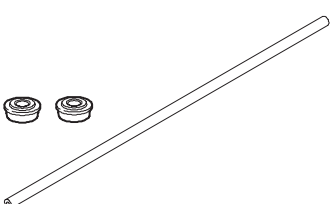
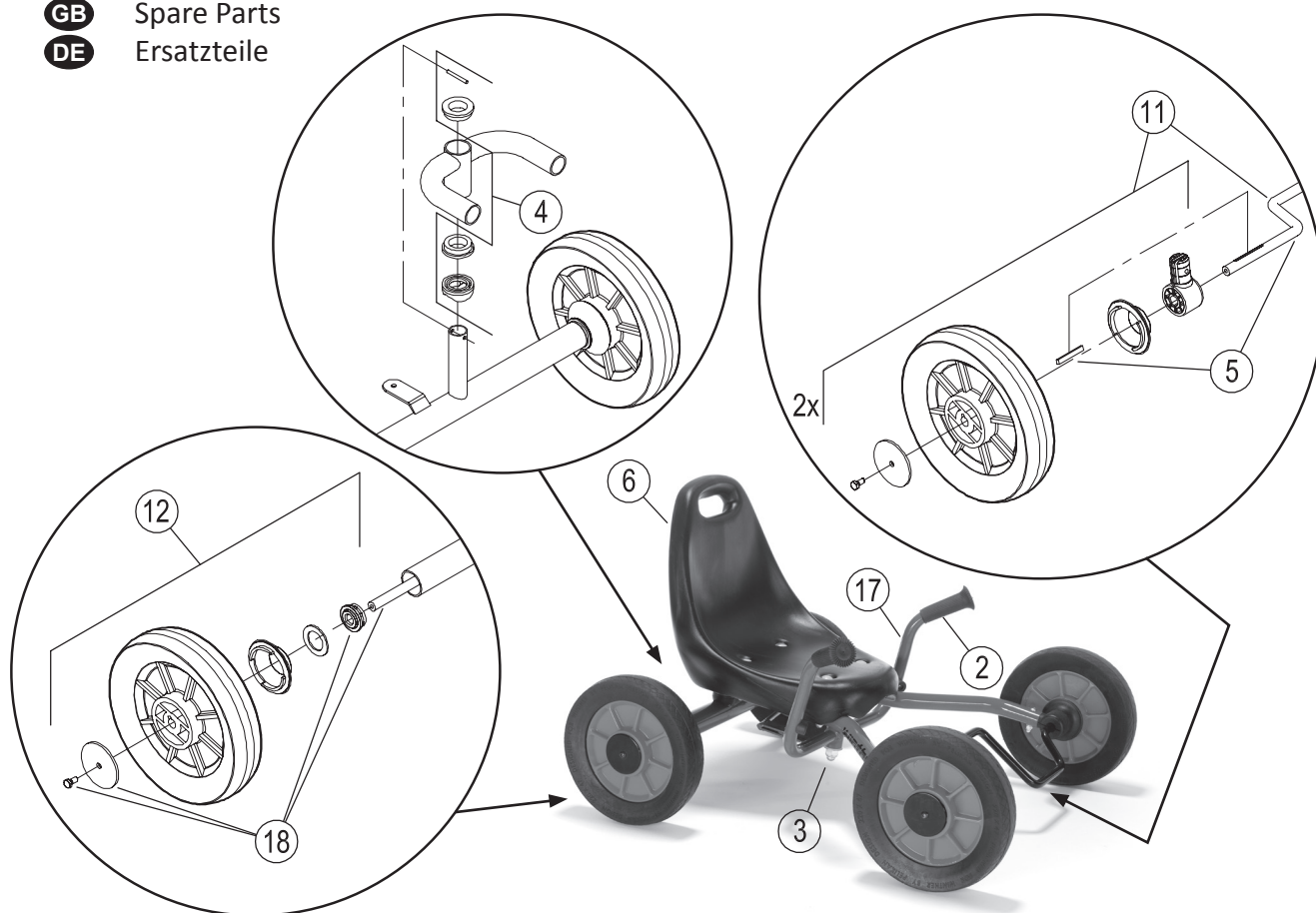

| 498.00 | | | | | |
|---------|-------|--|--|--|--|
| Version | | | | | |
| Pos. | 1.0 | | | | |
| 1 | - | | | | |
| 2 | 50001 | | | | |
| 3 | 50661 | | | | |
| 4 | 50662 | | | | |
| 5 | 50663 | | | | |
| 6 | 50664 | | | | |
| 7 | - | | | | |
| 8 | - | | | | |
| 9 | - | | | | |
| 10 | - | | | | |
| 11 | 50665 | | | | |
| 12 | 50666 | | | | |
| 13 | - | | | | |
| 14 | - | | | | |
| 15 | - | | | | |
| 16 | - | | | | |
| 17 | 50667 | | | | |
| 18 | 50668 | | | | |