

DE

Art.Nr. 3014501

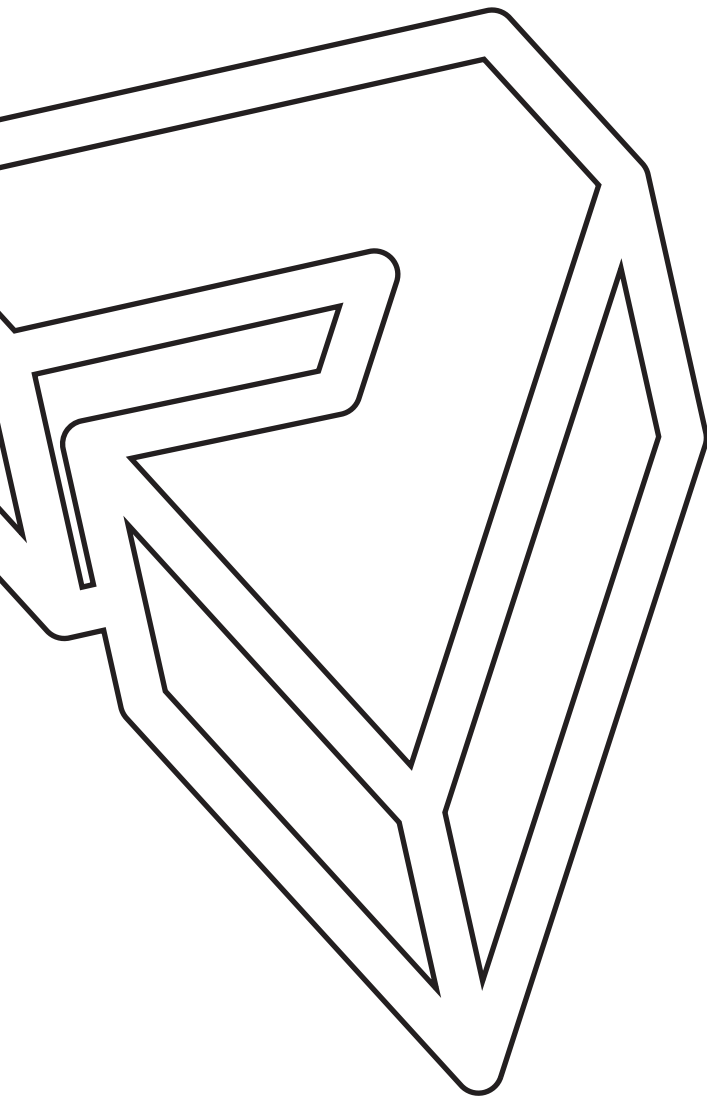

AQUA MARINA

2021

AUFBLASBARES
STAND-UP PADDLE
BEDIENUNGSANLEITUNG



WARNUNG

Zu Ihrer eigenen Sicherheit und der Ihrer Ausrüstung sollten Sie die folgenden Vorsichtsmaßnahmen treffen.

Nichtbeachtung von Warnhinweisen und Anweisungen können zu Sachschäden, schweren Verletzungen oder zum Tod führen.

ALLGEMEINE INFORMATIONEN ZUM PADDELN

Diese Anleitung soll Ihnen helfen, Ihr aufblasbares Stand-Up Paddle (nachfolgend ISUP genannt) sicher und mit Freude zu benutzen. Sie enthält Angaben zum ISUP, den gelieferten Geräten und Informationen zu deren Betrieb. Bitte lesen Sie sie sorgfältig durch und machen Sie sich mit dem ISUP vertraut, bevor Sie es benutzen.

SICHERHEIT

Es besteht die Gefahr von schweren Verletzungen oder Tod durch Ertrinken. Paddelsport kann sehr gefährlich und körperlich anstrengend sein. Der Anwender dieses Produktes kennt die Risiken des Paddelsports, er versteht und übernimmt sie. Beachten Sie die folgenden Warnhinweise und Sicherheitsstandards sorgfältig bei jeder Verwendung dieses Produkt Es.



aquamarina.com

WARNHINWEISE ANWEISUNG



VERBINDLICHE ANWEISUNG

- Persönliche Schwimmhilfe tragen
- Anleitung zuerst lesen
- Alle Luftkammern komplett aufblasen
- Anzahl der Benutzer
- Max. Tragfähigkeit
- Sicherheitsabstand zum Ufer 150 m (492.1 Fuß)



VERBOTSANWEISUNG

- Nicht in Wildwasser verwenden (außer BT-20RP)
- Nicht in brechenden Wellen verwenden (außer BT-20WA)
- Nicht bei Flachwasserströmung verwenden
- Nicht bei Hochseewind verwenden
- Nicht für Kinder im Alter von 14 Jahren und weniger (außer BT-19VIP)



ACHTUNG / GEFAHR / WARNUNG

- Nennbetriebsdruck
- Kein Schutz gegen Ertrinken



VERBINDLICHE ANWEISUNG





- Nur für Schwimmer
- Kinder immer im Wasser beaufsichtigen





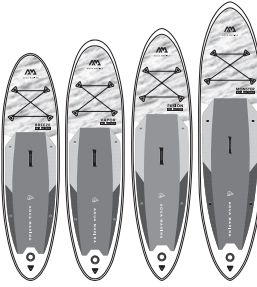

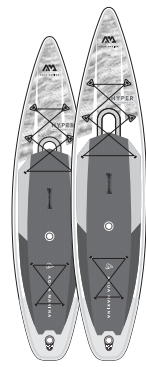
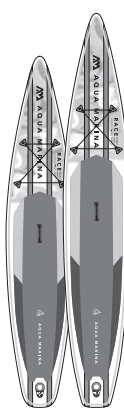



CN-ORP

Item No.:
Oriental Recreational Products (Shanghai) Co., Ltd.
1699 Daye Road, Fengxian Shanghai, China 201402

PRODUKTSERIENNUMMER

- Artikelnummer
- Herstellerdaten

UNIVERSAL								TOURING		RACING		FLUSS
												
MODELL												
BREEZE	VAPOR	FUSION	MONSTER	CORAL	BEAST	MAGMA	ATLAS	HYPER	HYPER	RACE	RACE	RAPID
BT-21BRP	BT-21VAP	BT-21FUP	BT-21MOP	BT-21COP	BT-21BEP	BT-21MAP	BT-21ATP	BT-21HY01	BT-21HY02	BT-21RA01	BT-21RA02	BT-20RP
GRÖSSE												
9'10"	10'4"	10'10"	12'0"	10'2"	10'6"	11'2"	12'0"	11'6"	12'6"	12'6"	14'0"	9'6"
30"	31"	32"	33"	31"	32"	33"	34"	31"	32"	27"	27"	33"
4.7"	6"	6"	6"	4.7"	6"	6"	6"	6"	6"	6"	6"	6"
300 cm	315 cm	330 cm	366 cm	310 cm	320 cm	340 cm	366 cm	350 cm	381 cm	381 cm	427 cm	289 cm
76 cm	79 cm	81 cm	84 cm	78 cm	81 cm	84 cm	86 cm	79 cm	81 cm	69 cm	69 cm	84 cm
12 cm	15 cm	15 cm	15 cm	12 cm	15 cm	15 cm	15 cm	15 cm	15 cm	15 cm	15 cm	15 cm
FIN												
1 MITTENFLOSSE				1 MITTENFLOSSE				1 RENNFLOSSE		1 RENNFLOSSE		1 FLUSSFLOSSE + 4 FESTE FLOSSEN
VOLUME												
220 L	310L	320L	380L	230L	300L	330L	390L	330L	370L	320L	360L	300L
MAX. BENUTZER GEWICHT												
220 LBS	308LBS	330LBS	374LBS	231LBS	308LBS	330LBS	396LBS	330LBS	374LBS	330LBS	352LBS	286LBS
100 KG	140KG	150KG	170KG	105KG	140KG	150KG	180KG	150KG	170KG	150KG	160KG	130KG
MAX. LUFTDRUCK												
15 PSI				15 PSI				15 PSI / 10 PSI (mittlere Kammer)		18 PSI		18 PSI

SURFEN	WINDSURFEN	MEHRPERSONEN				FITNESS	FISCHEN	KIND	
						<p>Yoga Dock BT-19YD Außendurchmesser: 290cm/9'6" Innendurchmesser: 170cm/67" Dicke: 12cm/4.7"</p>   			
WAVE BT-20WA	BLADE BT-20BL	SUPER TRIP BT-21ST01	SUPER TRIP TANDEM BT-20ST02	MEGA BT-20ME	AIRSHIP RACE BT-20AS	PEACE BT-20PC	DHYANA BT-21DHP	DRIFT BT-20DRP	VIBRANT BT-19VIP
8'8" 30" 4"	10'6" 33" 4.7"	12'2" 32" 6"	14'0" 34" 6"	18'1" 60" 8"	22'0" 34" 8"	8'2" 35" 6"	11'0" 36" 6"	10'10" 38" 6"	8'0" 28" 4"
265 cm 75 cm 10 cm	320 cm 84 cm 12 cm	370 cm 82 cm 15 cm	427 cm 86 cm 15 cm	550 cm 152 cm 20 cm	670 cm 87 cm 20 cm	250 cm 90 cm 15 cm	336 cm 91 cm 15 cm	330 cm 97 cm 15 cm	244 cm 71 cm 10 cm
1 MITTENFLOSSE	1 DOLCHFLOSSE + 1 MITTENFLOSSE	1 MITTENFLOSSE	2 MITTENFLOSSE	5 MITTENFLOSSE	1 RENNFLOSSE	/	1 MITTENFLOSSE	1 MITTENFLOSSE	1 MITTENFLOSSE
165L	280L	400L	500L	1400L	1000L	340L	360L	284L	140L
209LBS 95KG	264LBS 120KG	462LBS 210KG	507LBS 230KG	1433LBS 650KG	1014LBS 460KG	330LBS 150KG	352LBS 160KG	286LBS 130KG	132LBS 60KG
18 PSI	18 PSI	15 PSI	18 PSI	8 PSI	18 PSI	15 PSI		15 PSI (Brett) / 3PSI (seitenluftkammern)	15 PSI

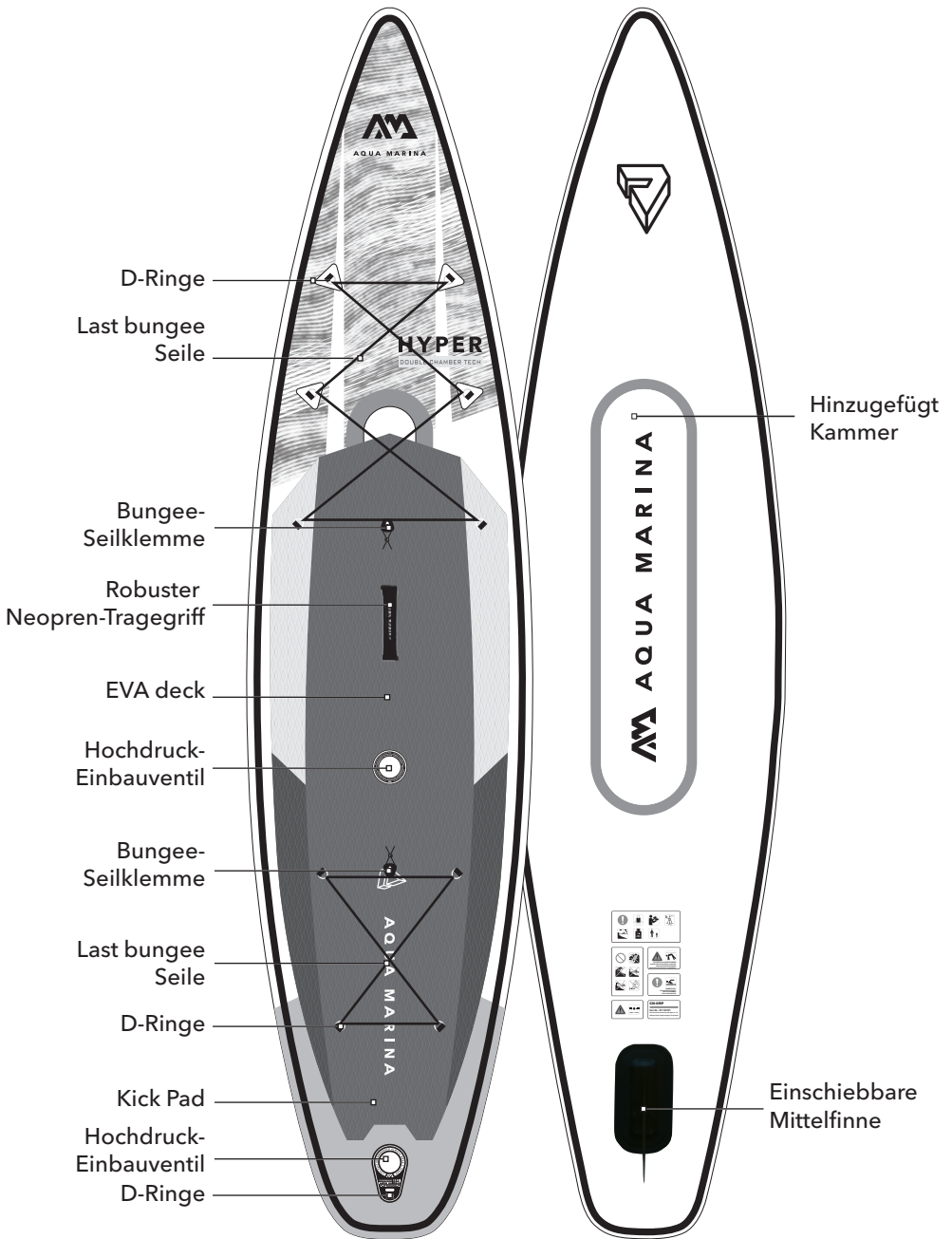

Die tatsächliche Konfiguration kann je nach Modell variieren.

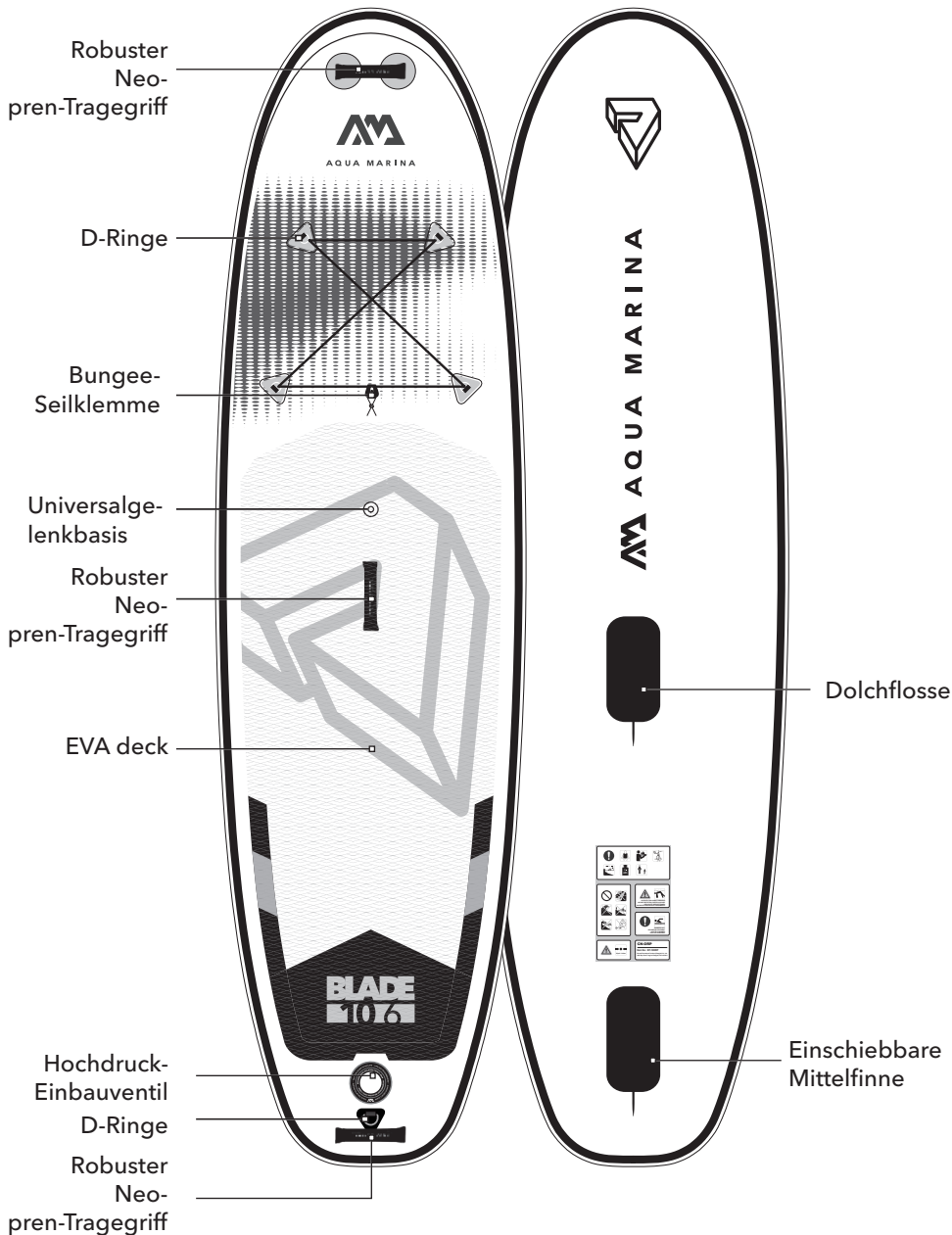

Die tatsächliche Konfiguration kann je nach Modell variieren.

ACCESSORIES

STANDARD

Rucksack mit Reissverschluss



Doppelaktion Pumpe - LIQUID AIR V1

(Mega/Airship Race/ Super Trip Tandem x 2)
(Coral/Beast/Magma/Atlas/Hyper/Race kommt mit LIQUID AIR V2)



Einschub Mittelfinne

(Mega x 5/
Super Trip Tandem x 2)



Last Bungee Seile

(außer Wave) (Hyper x 2)



Reparatursatz



Leine

(außer Super Trip/ Super Trip Tandem/Mega/
Airship Race/Peace/Yoga Dock)

DRIFT

Angelstockhalter x 2

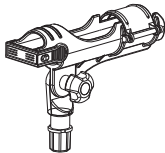

Paddelhalter

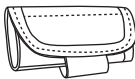

MEGA/YOGA DOCK

Tragtasche



CORAL/YOGA

Brettriemen

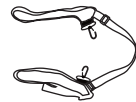

Paddelhalter
(Nur für Dhyana)

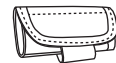

Riemen x 3
(Nur für Dhyana)

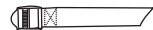

PADDEL

Paddel (außer Race/Hyper/Rapid/Super Trip/Mega/Airship Race/Blade/
Wave/Peace/Super Trip Tandem)

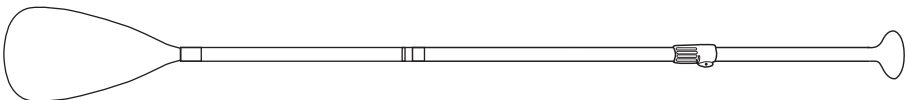

MONTAGE- UND DEMONTAGEANLEITUNG

A

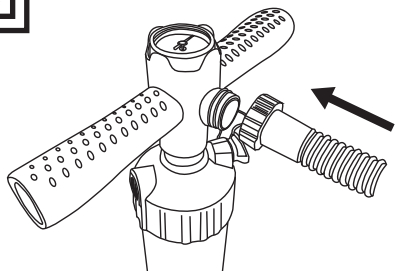

Pumpenaufstellung und Aufblasen

Verbinden Sie den Pumpenschlauch mit dem Manometer Gehäuse und sichern Sie ihn fest.

B

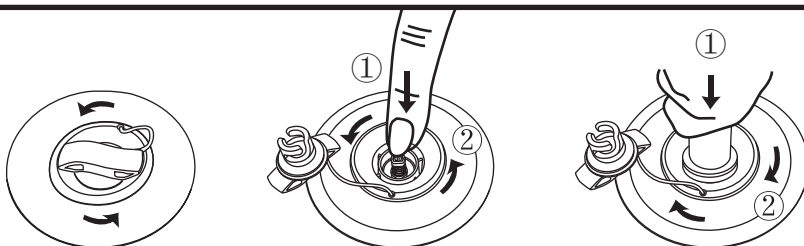

1. Ventildeckel durch Drehen gegen den Uhrzeigersinn lösen. Vergewissern Sie sich, dass das Ventil frei von Fremdkörpern, Sand oder Schmutz ist, bevor Sie es freigeben.
2. Drücken Sie den Ventilknopf hinein und drehen Sie ihn gegen den Uhrzeigersinn um 90 Grad, damit er nach oben springt und sich in der "OUT" Position befindet.
3. Setzen Sie den Pumpenschlauch ein und drehen Sie ihn um 45 Grad im Uhrzeigersinn, um ihn zu arretieren. Aufpumpen, bis der gewünschte Druck erreicht ist.



12PSI Minimum (8PSI für MEGA / 10 PSI für HYPER - Innenkammer) für Aufblasbretter Betrieb und 15PSI Maximum (18PSI für SUPER TRIP TANDEM/ RAPID/ RACE/ WAVE/ BLADE/ AIRSHIP RACE). Übermäßig Aufblasen Entfällt die Garantie.

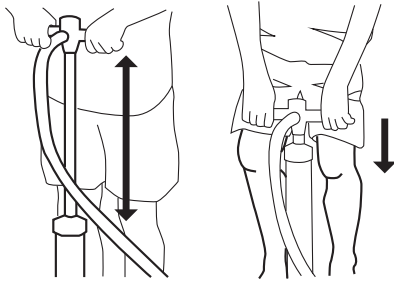

Schneller aufpumpen mit weniger Aufwand

- Verwenden Sie den gesamten Bereich des Pumpenzylinders, während Sie Ihre Arme ausgestreckt halten.
- Beugen Sie Ihre Knie und benutzen Sie das Körpergewicht.

C

LIQUID AIR V1

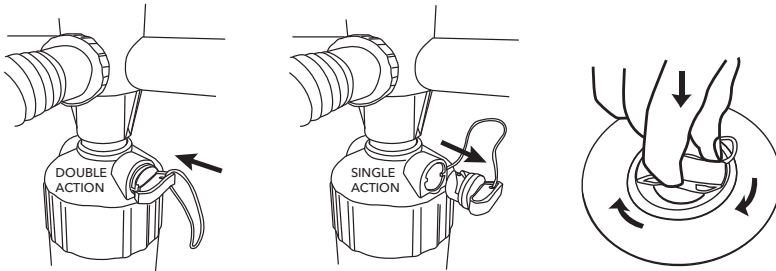

1. Verwenden Sie den **DOPPELAKTION**-Modus, indem Sie den Lufthahn schließen, um das Brett bis zu 7 psi zu pumpen.
2. Schalten Sie in die Position **EINZELAKTION**, indem Sie den Lufthahn öffnen, um das Brett bis zu 15 - 18 psi zu pumpen.

LIQUID AIR V2

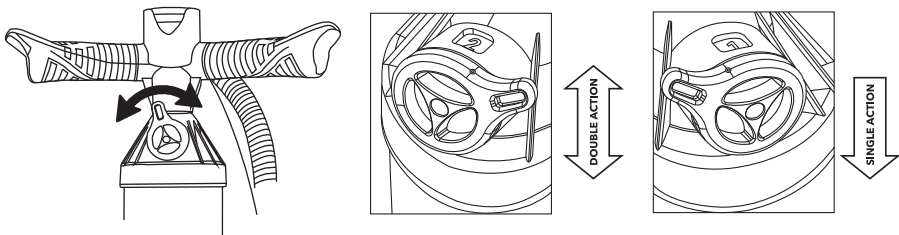

1. Verwenden Sie den **DOPPELAKTION**-Modus, wobei die obere Kappe „2“ anzeigt, um das Board auf 0,48 bis 0,69 bar (7 bis 10 psi) aufzupumpen.
2. Drehen Sie den Schalter auf den **EINZELAKTION**-Modus, wobei die obere Kappe „1“ anzeigt, um das Board auf 1,03 bis 1,24 bar (15 bis 18 psi) aufzupumpen.

Nach dem Aufblasen den Ventildeckel wieder einsetzen und im Uhrzeigersinn festziehen.

VORSICHT UND TIPPS

- Elektrische Pumpen können verwendet werden, um das Brett bis zu 80-90% aufzublasen. Der erforderliche Restdruck sollte jedoch mit der Handpumpe erreicht werden, um ein Überfüllen zu vermeiden.
- Verwenden Sie keine Druckluftkompressoren, da dadurch die Garantie für das Brett erlischt.
- Stellen Sie vor langen Fahrten sicher, dass das Brett aufgeblasen ist und mindestens 24 Stunden lang Druck aufrechterhalten hat.

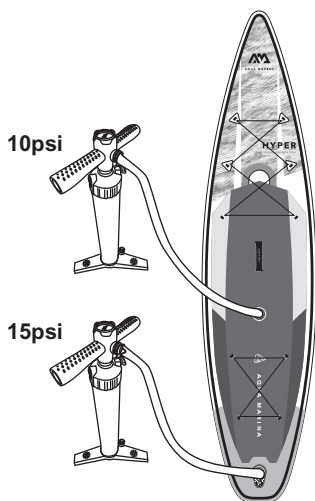

Für Doppelkammer-Brett

Für die beste Leistung sollte die Doppelkammer immer aufgeblasen werden, um höchste Steifigkeit und Sicherheit zu gewährleisten.

- Füllen Sie die innere Kammer bis zu 10 PSI auf.
- Füllen Sie dann die äußere Kammer bis zu 15 PSI auf.

D

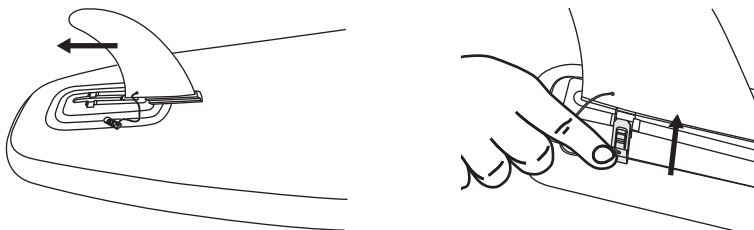

Installation der einschiebbaren Mittelfinne-

Sobald das Brett aufgeblasen ist, schieben Sie die große Mittelfinne in den Finnenboden und stecken Sie den Steckbolzen ein.

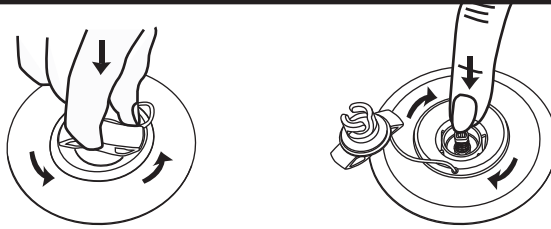
E**Luft ablassen**

Um Ihr Brett zu entlüften, folgen Sie den Anweisungen unten.

1. Ventilkappe durch Drehen gegen den Uhrzeigersinn lösen. Vergewissern Sie sich, dass das Ventil von Fremdkörpern, Sand oder Schmutz befreit ist, bevor Sie es freigeben.
2. Ventilknopf eindrücken und im Uhrzeigersinn drehen, um ihn in der Position DOWN zu verriegeln.

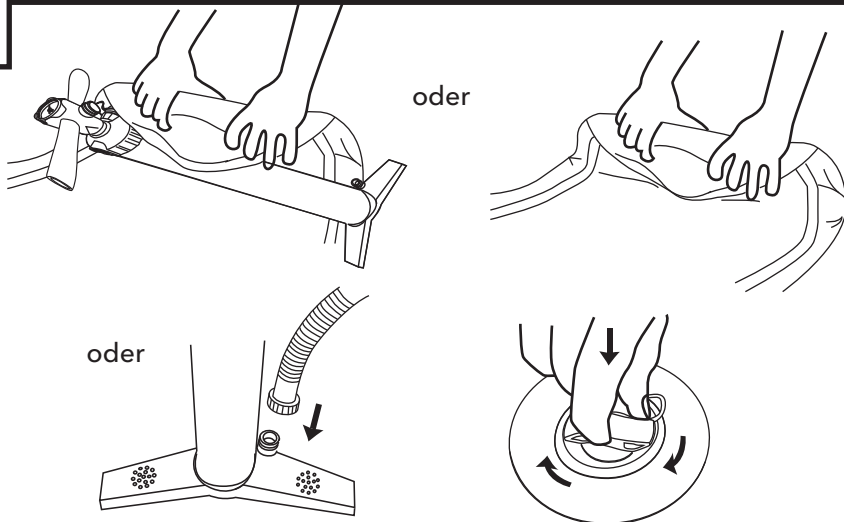
F

oder

oder

Faltschritte

1. Wir empfehlen, Ihr Board um die Pumpe herumzuwickeln und alle Luft heraus zu pressen, während Sie es zusammenrollen. Alternativ können Sie das Board von der Nase bis zum Tail aufrollen, indem Sie die im Inneren verbliebene Luft heraus drücken bzw. die Pumpe in der Stellung „Luftablassen“ (nur für LIQUID AIR V1) für ein schnelleres Entleeren der Luft verwenden.
2. Drücken Sie die gesamte Luft aus dem Brett, setzen Sie den Ventildeckel zurück und ziehen Sie ihn im Uhrzeigersinn an, um ihn zu verriegeln.

HINWEIS:

Für RACE-Boards empfehlen wir dennoch das Herumwickeln um die Pumpe. Alternativ falten Sie dieses bitte entsprechend der gepunkteten Linie, wie unten dargestellt (Abb. A), um ein Knicken der Seitenleistenpolster zu vermeiden.

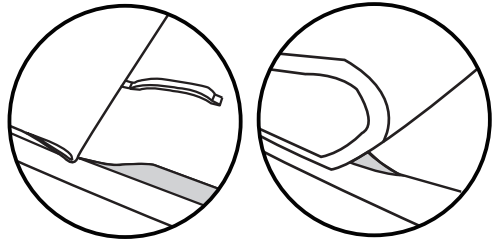

TIP:

Beginnen Sie hier zu falten.

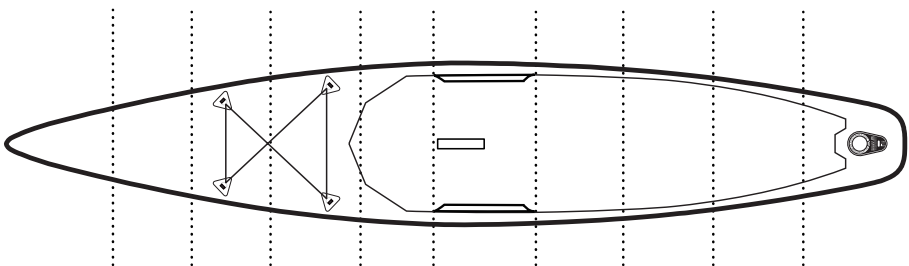
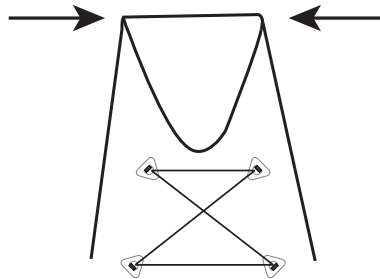

(Abb. A)

WIE MAN EINEN SCHNITT ODER EIN LOCH IM AUFBLASBAREN BRETT REPARIERT

G

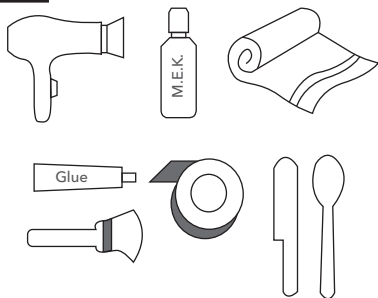

MATERIALIEN

- Klebe (AQUASEAL® Ist empfohlen)
- Aceton oder Methylethylketon (M.E.K.)
- Haartrockner
- Bürste
- Band
- Spatel oder Löffel
- Handtuch
(Nicht im SUP-Board Satz enthalten)



1

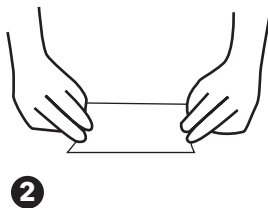

2

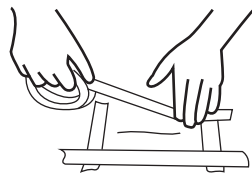

3

1. Reinigen Sie den Bereich um den Schnitt oder den Einstich mit Aceton oder M.E.K.
2. Zeichnen Sie den Umriss des Flickens mit Kreide oder Bleistift (keine Tinte verwenden). Schneiden Sie das Pflaster ab, bedecken Sie den Schnitt oder die Punction mit ca. 2,5 cm (1 Zoll) Überlappung auf allen Seiten.
3. Klebeband entlang der Kontur des Pflasters anbringen. Dadurch wird verhindert, dass sich der Kleber außerhalb des Flickensbereichs ausbreitet.

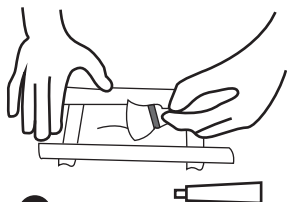

4

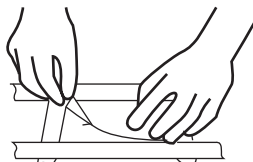

5

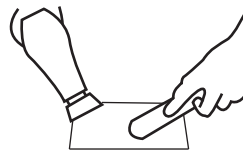

6

4. Kleber mit einem Pinsel oder einem anderen Applikator auf das Brett und das Pflaster auftragen. Vergewissern Sie sich, dass der Kleber gleichmäßig und vollständig über das Brett und den Flickens verteilt ist.

Lassen Sie den Kleber 5 Minuten trocknen.

5. Tragen Sie das Pflaster von einer Seite auf die andere Seite auf und achten Sie darauf, keine Luftblasen einzufangen.
6. Verwenden Sie einen Haartrockner, um den Bereich sanft zu erwärmen, um eine gute Verbindung zwischen dem Patch und dem Board zu gewährleisten. Verwenden Sie einen Metallspachtel oder -löffel und festen Druck, um eine gute Haftung zu gewährleisten und eventuelle Luftblasen zu entfernen.

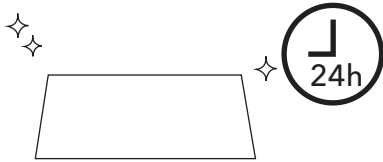

Lassen Sie den Kleber 24 Stunden vor dem Gebrauch ohne Aufblasen aushärten.

BEHEBEN EINES UNDICHTEN VENTILS

H

A. Versuchen Sie, das Ventil festzuziehen

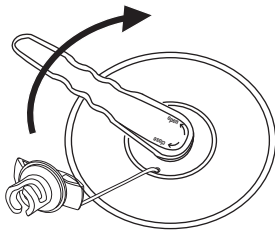

1. Pumpen Sie Ihr Brett bis zum maximalen Luftdruck auf
2. Stecken Sie Ihren Ventilschlüssel in das Ventil und drehen Sie ihn im Uhrzeigersinn, um das Ventil wieder auf dem Brett festzuziehen

B. Montage oder Ersatz eines Ventils

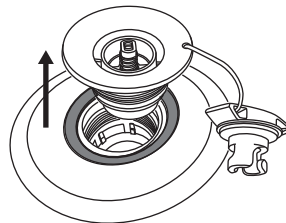
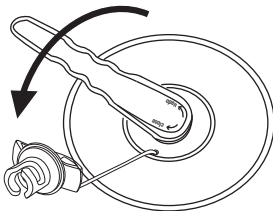

1. Entleeren Sie Ihr Brett vollständig
2. Öffnen Sie die Staubkappe, stecken Sie den Ventilschlüssel in das Ventil und drehen Sie ihn gegen den Uhrzeigersinn, um das Ventil zu entfernen

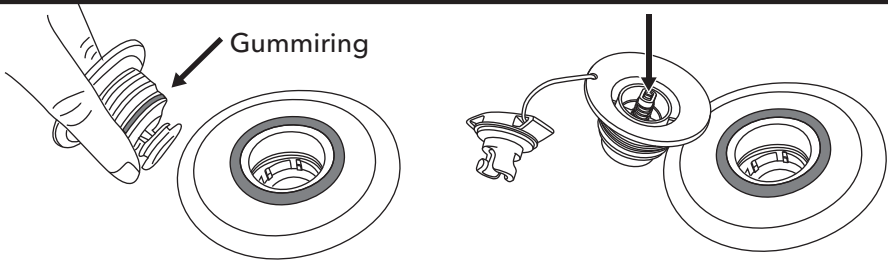

3. Überprüfen Sie den Gummiring, um sicherzustellen, dass er sich in der richtigen Position befindet, dicht um das Ventil liegt und sich dort keine Rückstände befinden
4. Stellen Sie sicher, dass die Stiffeder ordnungsgemäß funktioniert und dass keine Risse an den Kanten vorhanden sind

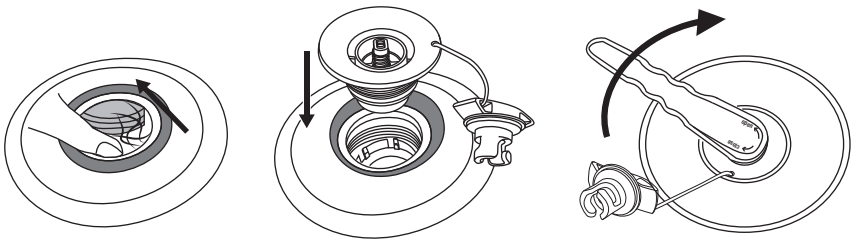

5. Vergewissern Sie sich, dass das Fallstichmaterial keine Fäden enthält
6. Beachten Sie, dass das untere Teil des Ventils an nichts befestigt ist
7. Bauen Sie das Ventil wieder in Ihr Brett ein
8. Richten Sie alle Gewinde aus und drehen Sie sie zum Festziehen
9. Sobald das Ventil handfest angezogen ist, verwenden Sie den Ventilschlüssel, um es vollständig abzudichten



HINWEIS: Verwenden Sie den Schraubenschlüssel richtig, indem Sie ihn mit einer Hand oben drauf drücken.

PADDEL ZUSAMMENBAU

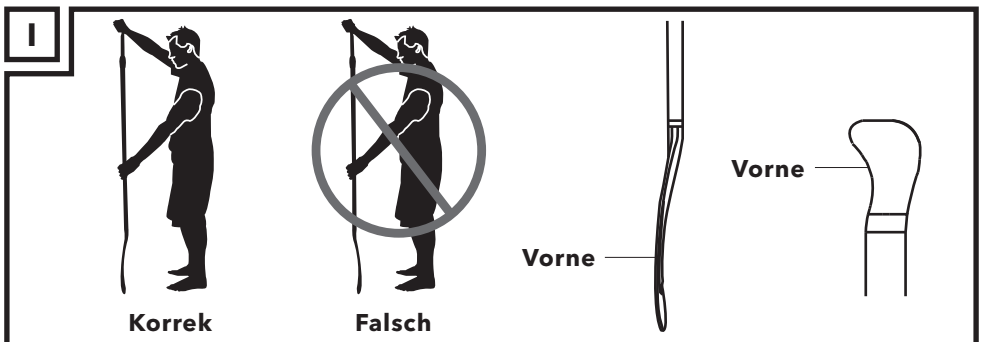

Aqua Marina 3-teilige verstellbare Welle verwendet ein sicheres Federstiftsystem und wird mit einer zusätzlichen Klemme geliefert, um jegliches Spiel zu reduzieren.

SICHERES FEDERSTIFT

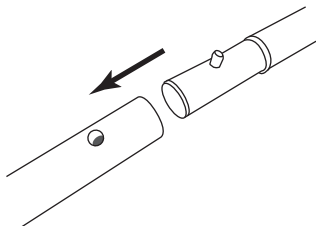

KLEMMSYSTEM FÜR ALUMINIUMSTANGE

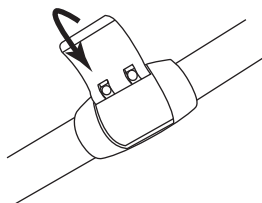

KLEMMSYSTEM FÜR KOHLE- UND GLASFASERSTANGE

Einfache Einstellung des Festsitzes durch Drehen der Haspel, um jegliches Spiel zu vermeiden.

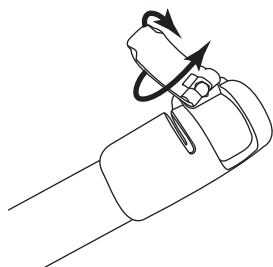

Stellen Sie sicher, dass die Mittellinie mit der Anzeige auf der Klemme ausgerichtet ist

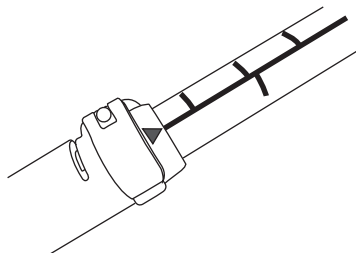

HINWEIS: Lassen Sie stets nach der Verwendung das Restwasser aus dem Padelrohr ab.

3 PCS ADJUSTABLE

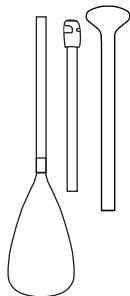

- **SPORTS III** B0303012
Anpassbares Aluminium iSUP Paddel
- **SOLID** B0303013
Anpassbares Fiberglas iSUP Paddel
- **CARBON GUIDE** B0303014
Kohle- / Glasfaser iSUP Paddel
- **CARBON PRO** B0303015
Kohle iSUP Paddel

2 PCS ADJUSTABLE

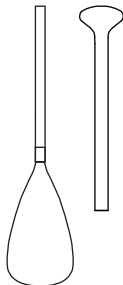

- **CARBON X** B0303016
2-teiliges iSUP-Paddel aus Karbon

2-IN-1

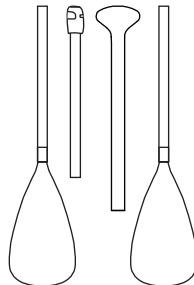

- **DUAL-TECH** B0303011
2-in-1 iSUP & Kayak Paddel

WIE MAN EINEN SICHERHEITSLAISEN TRAGT

TAILLE



FLUSS-LEASH
(SICHERUNGSLAINE)
B0303025

KNÖCHEL



SPIRALFÖRMIGE
LEASH
(SICHERUNGSLAINE)
B0303023



SURFBOARD
LEASH
(SICHERUNGSLAINE)
B0303024



STANDARD-LEASH
(SICHERUNGSLAINE)
B0302765

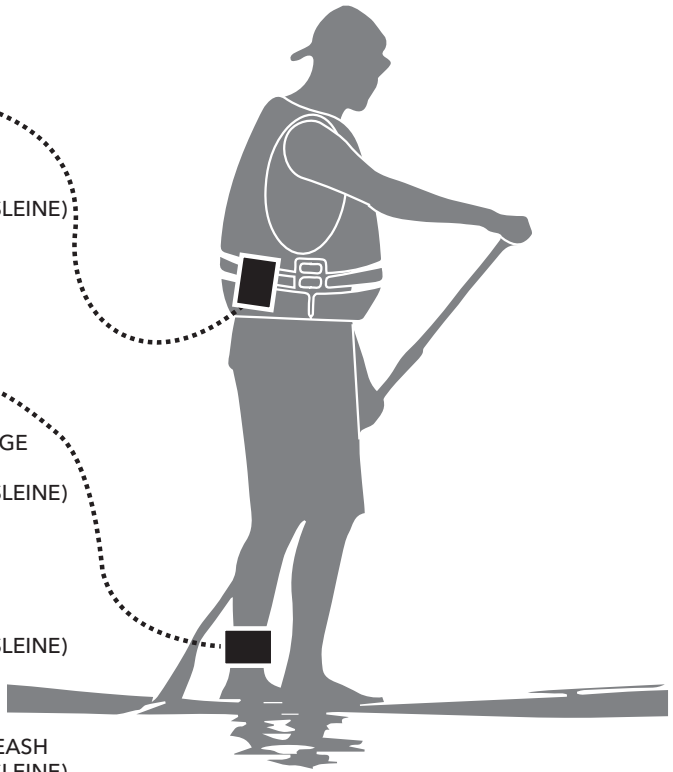

MONTAGE DER STANDARD-LEASH (SICHERUNGSLAINE)

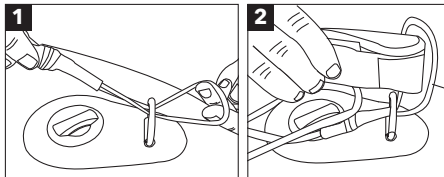

1

2

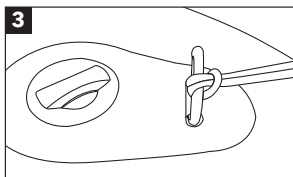

3

MONTAGE DER SPIRALFÖRMIGEN/SURFBOARD/ FLUSS-LEASH (SICHERUNGSLAINE)

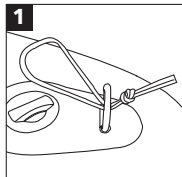

1

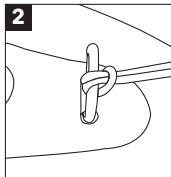

2

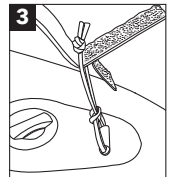

3

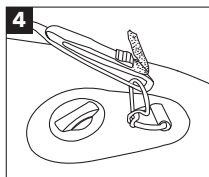

4

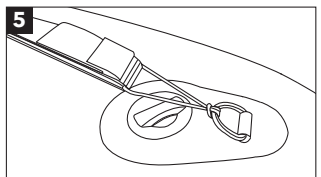

5

Häufige Fragen

F: Wie viel Luft sollte ich in mein Brett pumpen und wie lange dauert das Aufblasen?

A: Der empfohlene Druck ist 15 - 18PSI (8PSI für MEGA, 10 PSI für HYPER - Innenkammer) , wenn er höher ist, steigt die Gefahr des Ausblasens und der Beschädigung. Je nach Größe Ihres Brettes kann es zwischen 5 und 8 Minuten dauern.

F: Beim Lösen der Pumpe vom Brett beginnt die Luft aus dem Ventil zu entweichen. Wie kann ich das verhindern?

A: Die Luft entweicht, wenn der Ventildfederstift in der Entlüftungsstellung verbleibt. Einfach nach unten drücken und den Stift drehen, bis er sich in die Aufblasposition hebt und die Luft nicht mehr entweichen kann; das Brett weiter bis zum Druck aufblasen.

F: Kann ich mein Brett in der Sonne und über Nacht aufgeblasen lassen?

A: Wenn Sie das Brett aufgeblasen lassen, empfehlen wir Ihnen dringend, es von der direkten Sonneneinstrahlung zu entfernen und das Brett auf mindestens 10PSI (5PSI für MEGA) zu entlüften.

F: Wie soll ich mein Brett reinigen und wie soll ich es aufbewahren?

A: Wir empfehlen nur Wasser und eine milde Seife. Starke Reinigungs- und Lösungsmittel können Ihr Brett beschädigen. Am besten reinigen und trocknen Sie Ihr Brett, nehmen die Finnen heraus, rollen es auf und legen es in die Tasche.

F: Kann ich mein Brett selbst reparieren?

A: Ja, Sie können die im Handbuch aufgeführten erforderlichen Werkzeuge mit den mitgelieferten Reparatur-Kit benutzen oder uns eine E-Mail schicken, um weitere Informationen zu erhalten unter info@aquamarina.com.

GARANTIE

**1
JAHR**

AM garantiert dem ursprünglichen Käufer für die Dauer von einem (1) Jahr ab Kaufdatum, dass dieses Produkt frei von wesentlichen Material- oder Verarbeitungsfehlern ist. Diese Garantie unterliegt folgenden Einschränkungen

1. Die Garantie ist nur gültig, wenn dieses Produkt für normale Freizeitaktivitäten verwendet wird und nicht für Produkte, die im Verleih oder Schulbetrieb verwendet werden.
2. AM wird die endgültige Garantiebestimmung vornehmen, die eine Inspektion und/oder Fotos des Geräts erfordern kann, die den/die Defekt(e) deutlich zeigen. Falls erforderlich, müssen diese Informationen an den AM-Händler in Ihrem Land mit frankiertem Porto geschickt werden. Das Produkt kann nur zurückgegeben werden, wenn der AM-Händler im Voraus eine Rückgabeberechtigungsnummer angegeben hat. Die Rücksendenummer muss auf der Außenseite des Pakets deutlich gekennzeichnet sein, sonst wird sie abgelehnt.
3. Wenn ein Produkt von AM als fehlerhaft eingestuft wird, deckt die Garantie nur die Reparatur oder den Ersatz des fehlerhaften Produkts ab. AM ist nicht verantwortlich für Kosten, Verluste oder Schäden, die durch Verlust oder Missbrauch dieses Produkts entstehen.
4. Diese Garantie erstreckt sich nicht auf Schäden, die durch Missbrauch, Misshandlung, Vernachlässigung, normalen Verschleiß, einschließlich, aber nicht beschränkt auf Einstiche, Schäden durch übermäßige Hitzeeinwirkung, Schäden durch unsachgemäße Handhabung und Lagerung, Schäden, die verursacht werden durch Einsatz bei Wellen oder Küstenbrechern, Brettbruch durch Auffüllen oder Absturz unter Surfbedingungen oder Schäden, die nicht durch Material- und Verarbeitungsfehler verursacht wurden.
5. Dieses Produkt darf nicht verändert und/oder mit einem Motor außer einer AM BlueDrive Power-Finne ausgestattet werden.
6. Dieses Produkt darf nicht über die vom Hersteller empfohlene maximale Tragfähigkeit hinaus verwendet werden.
7. Diese Garantie erlischt, wenn eine nicht autorisierte Reparatur, Änderung oder Modifikation an irgendeinem Teil der Ausrüstung vorgenommen wurde.
8. Die Garantie für alle reparierten oder ausgetauschten Geräte gilt ab dem Datum des nur Originalkauf.
9. Der Original-Kaufbeleg muss allen Garantieansprüchen beiliegen. Der Name des Händler und Kaufdatum müssen deutlich und lesbar sein.
10. Es gibt keine Garantien, die über die hier angegebene Garantie hinausgehen.



WARNUNG

Dieses Produkt ist normgerecht für einen bestimmten Einsatzzweck ausgelegt. Änderungen oder Umbauten, die über die vom Hersteller angegebenen Werte hinausgehen, können zu ernsthaften Risiken für den Benutzer führen und führen zum Erlöschen der Garantie.

EN

Art.Nr. 3015908

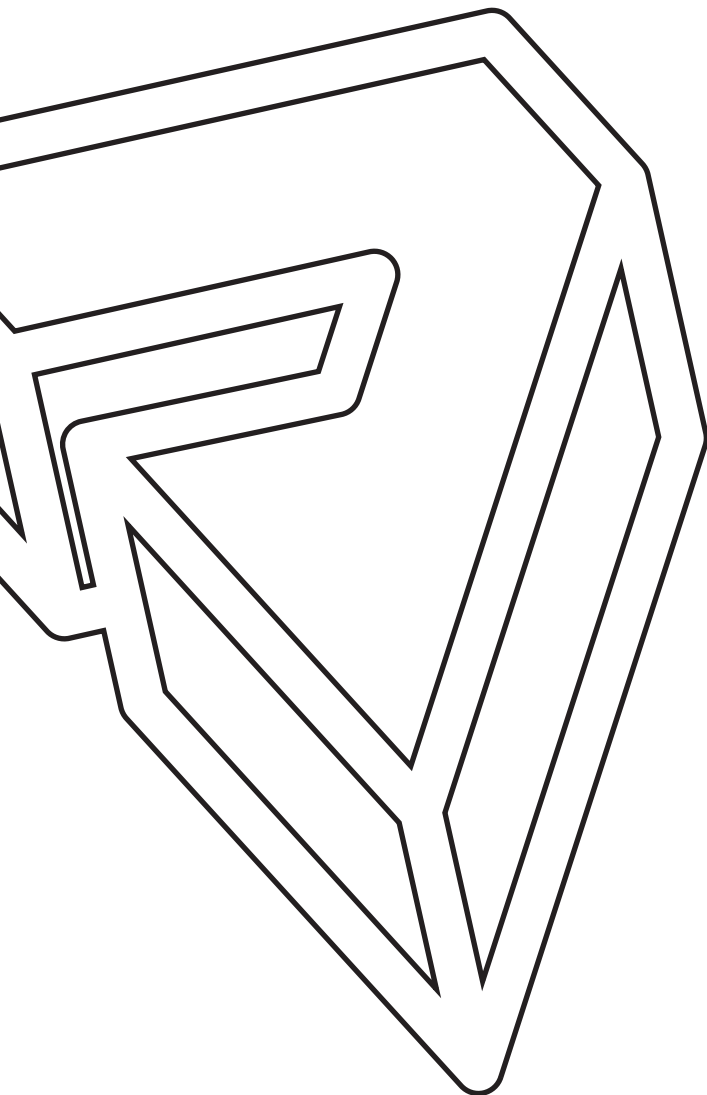

AQUA MARINA

2021

INFLATABLE
STANDUP PADDLE BOARD
USER MANUAL



WARNING

For your own safety and that of your equipment, make sure to take the following precautions. Failure to follow warning notices and instruction may result in property damage, serious injury or death.

GENERAL PADDLING INFORMATION

This manual has been compiled to help you operate your Inflatable Stand Up Paddle Board (Hereinafter referred to as ISUP) with safety and pleasure. It contains details of the ISUP, the equipment supplied, and information on their operation. Please read it carefully and familiarize yourself with the ISUP before using it.

SAFETY

There is a risk of serious injury or death from drowning. Paddle sports can be very dangerous and physically demanding. The user of this product acknowledges, understands, and assumes the risks involved in paddle sports. Observe the following warning labels and safety standards carefully whenever using this product.



aquamarina.com

WARNING LABEL INSTRUCTIONS



MANDATORY INSTRUCTION

- Wear personal flotation device
- Read instructions first
- Fully inflate all air chambers
- Numbers of users
- Max. load capacity
- Safe distance to shore 150 m (492.1')



PROHIBITION INSTRUCTION

- Do not use in white water (except BT-20RP)
- Do not use in breaking waves (except BT-20WA)
- Do not use in offshore current
- Do not use in offshore wind
- Not for children 14 years old and below (except BT-19VIP)



ATTENTION / DANGER / WARNING

- Design working pressure
- No protection against drowning



MANDATORY INSTRUCTION

- Swimmers only
- Always supervise children in water





CN-ORP





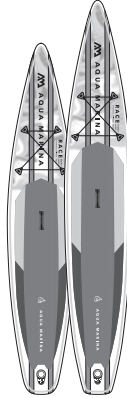

Item No.:

Oriental Recreational Products (Shanghai) Co., Ltd.
1699 Daye Road, Fengxian Shanghai, China 201402

PRODUCT SERIAL NUMBER

- Item No.
- Manufacturer information

ALL AROUND								TOURING		RACING		RIVER
												
MODEL												
BREEZE	VAPOR	FUSION	MONSTER	CORAL	BEAST	MAGMA	ATLAS	HYPER	HYPER	RACE	RACE	RAPID
BT-21BRP	BT-21VAP	BT-21FUP	BT-21MOP	BT-21COP	BT-21BEP	BT-21MAP	BT-21ATP	BT-21HY01	BT-21HY02	BT-21RA01	BT-21RA02	BT-20RP
SIZE												
9'10"	10'4"	10'10"	12'0"	10'2"	10'6"	11'2"	12'0"	11'6"	12'6"	12'6"	14'0"	9'6"
30"	31"	32"	33"	31"	32"	33"	34"	31"	32"	27"	27"	33"
4.7"	6"	6"	6"	4.7"	6"	6"	6"	6"	6"	6"	6"	6"
300 cm	315 cm	330 cm	366 cm	310 cm	320 cm	340 cm	366 cm	350 cm	381 cm	381 cm	427 cm	289 cm
76 cm	79 cm	81 cm	84 cm	78 cm	81 cm	84 cm	86 cm	79 cm	81 cm	69 cm	69 cm	84 cm
12 cm	15 cm	15 cm	15 cm	12 cm	15 cm	15 cm	15 cm	15 cm	15 cm	15 cm	15 cm	15 cm
FIN												
1 CENTER FIN				1 CENTER FIN				1 RACING FIN		1 RACING FIN		1 RIVER FIN + 4 FIXED FINS
VOLUME												
220 L	310L	320L	380L	230L	300L	330L	390L	330L	370L	320L	360L	300L
MAX. RIDER WGT												
220 LBS	308LBS	330LBS	374LBS	231LBS	308LBS	330LBS	396LBS	330LBS	374LBS	330LBS	352LBS	286LBS
100 KG	140KG	150KG	170KG	105KG	140KG	150KG	180KG	150KG	170KG	150KG	160KG	130KG
MAX. AIR PRESSURE												
15 PSI				15 PSI				15 PSI / 10 PSI (center chamber)		18 PSI		18 PSI

SURF	WINDSURF	MULTI-PERSON				FITNESS		FISHING	KID
						 <p>Yoga Dock BT-19YD Outer Diameter: 290cm/9'6" Inner Diameter: 170cm/67" Thickness: 12cm/4.7"</p>			
WAVE BT-20WA	BLADE BT-20BL	SUPER TRIP BT-21ST01	SUPER TRIP TANDEM BT-20ST02	MEGA BT-20ME	AIRSHIP RACE BT-20AS	PEACE BT-20PC	DHYANA BT-21DHP	DRIFT BT-20DRP	VIBRANT BT-19VIP
8'8" 30" 4"	10'6" 33" 4.7"	12'2" 32" 6"	14'0" 34" 6"	18'1" 60" 8"	22'0" 34" 8"	8'2" 35" 6"	11'0" 36" 6"	10'10" 38" 6"	8'0" 28" 4"
265 cm 75 cm 10 cm	320 cm 84 cm 12 cm	370 cm 82 cm 15 cm	427 cm 86 cm 15 cm	550 cm 152 cm 20 cm	670 cm 87 cm 20 cm	250 cm 90 cm 15 cm	336 cm 91 cm 15 cm	330 cm 97 cm 15 cm	244 cm 71 cm 10 cm
1 CENTER FIN	1 CENTER FIN+1 DAGGER FIN	1 CENTER FIN	2 CENTER FINS	5 CENTER FINS	1 RACING FIN	/	1 CENTER FIN	1 CENTER FIN	1 CENTER FIN
165L	280L	400L	500L	1400L	1000L	340L	360L	284L	140L
209LBS 95KG	264LBS 120KG	462LBS 210KG	507LBS 230KG	1433LBS 650KG	1014LBS 460KG	330LBS 150KG	352LBS 160KG	286LBS 130KG	132LBS 60KG
18 PSI	18 PSI	15 PSI	18 PSI	8 PSI	18 PSI	15 PSI	15 PSI	15 PSI (board) / 3PSI (side air chambers)	15 PSI

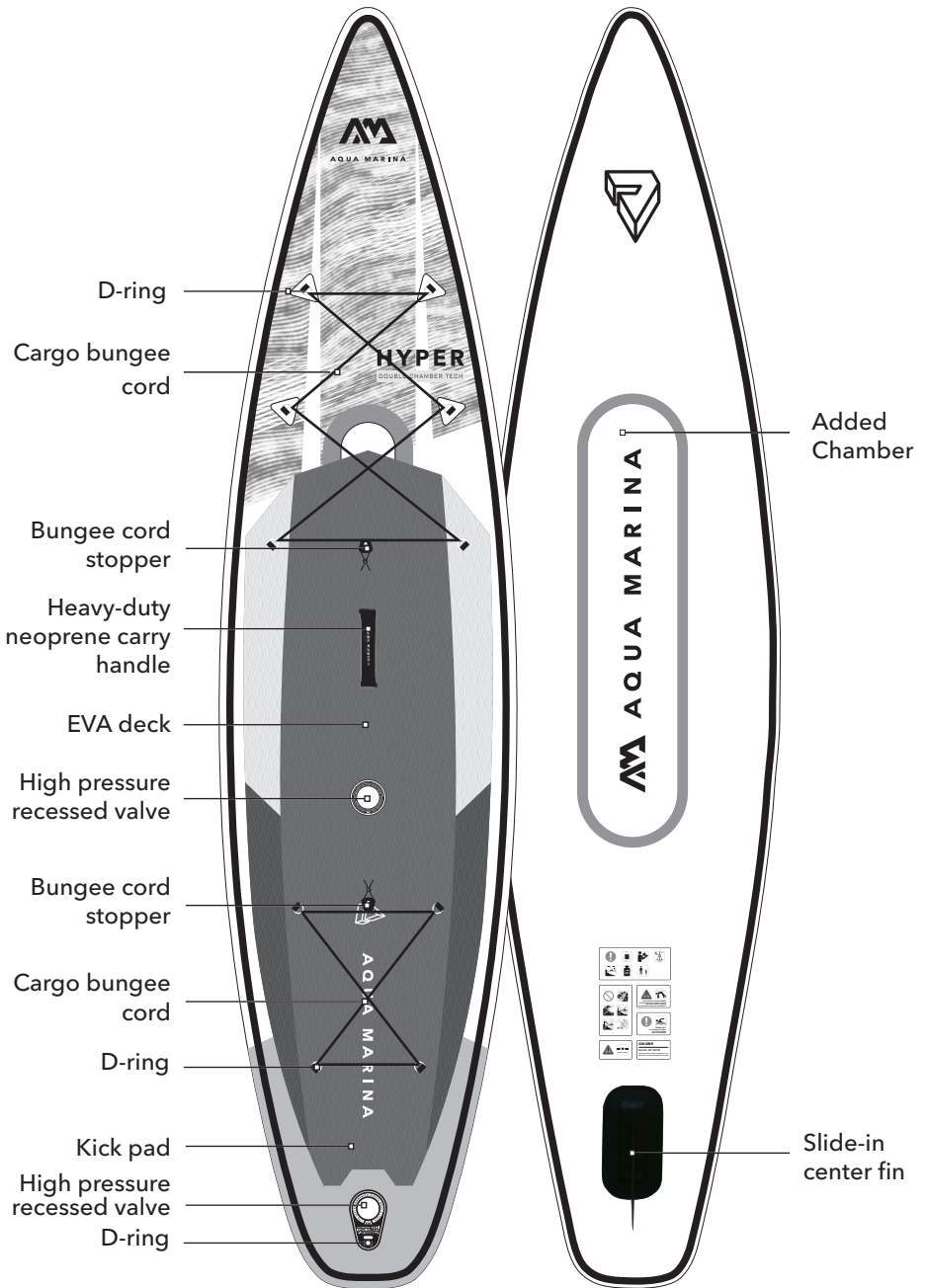

Actual configuration may vary upon different models.

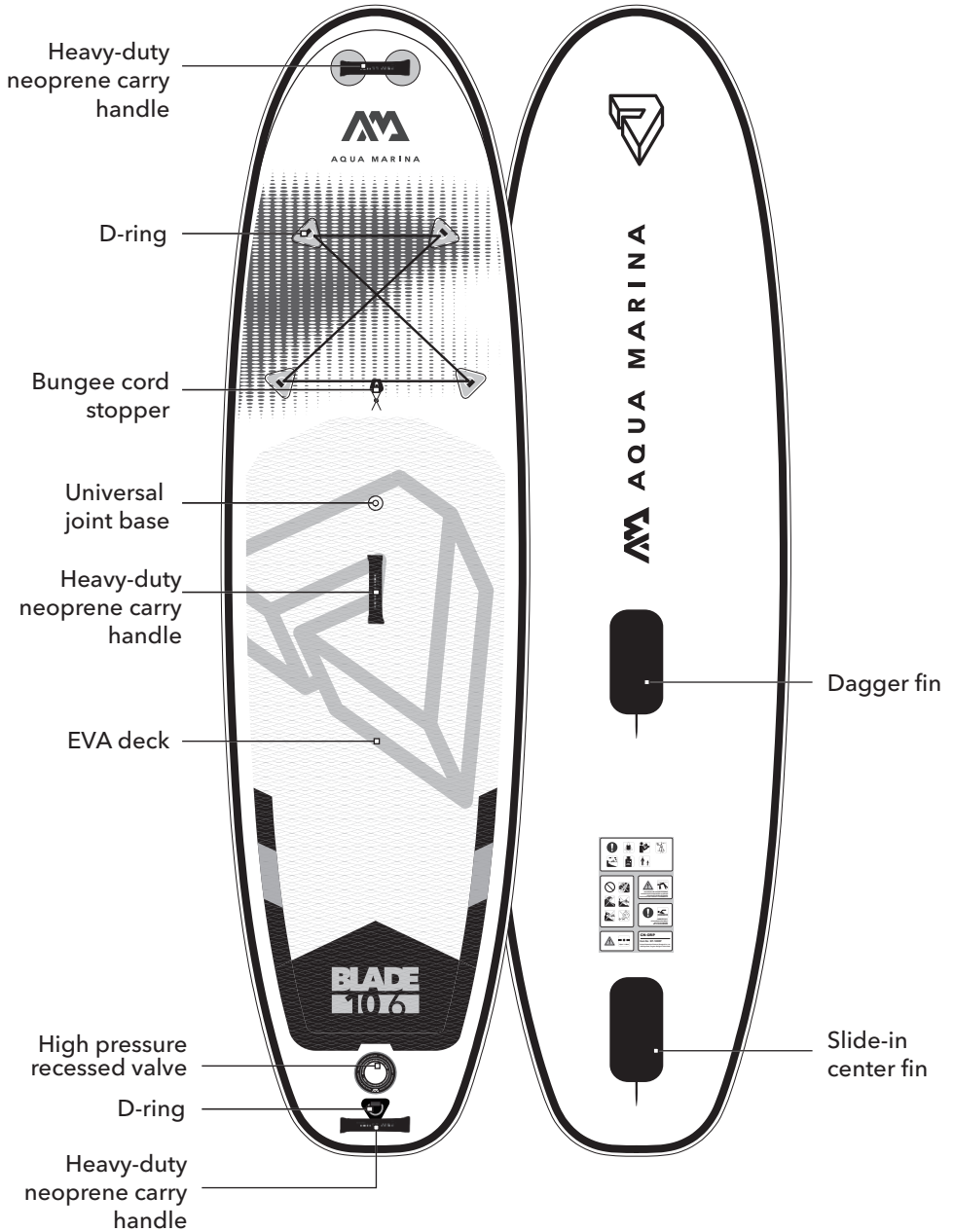

Actual configuration may vary upon different models.

ACCESSORIES

STANDARD

Zip Backpack



Double-Action Pump - LIQUID AIR V1

(Mega/Airship Race/ Super Trip Tandem x 2)
(Coral/Beast/Magma/Atlas/Hyper/Race comes with LIQUID AIR V2)



Slide-in Center Fin

(Mega x 5/
Super Trip Tandem x 2)



Cargo Bungee Cord

(except Wave) (Hyper x 2)



Repair Kit



Leash

(except Super Trip/ Super Trip Tandem/Mega/
Airship Race/Peace/Yoga Dock)

DRIFT

Fishing Rod Holder x 2

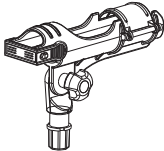

Paddle Holder

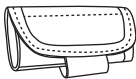

MEGA/YOGA DOCK

Carry Bag



CORAL/YOGA

Board Strap



Paddle Holder
(Only for Dhyana)



Straps x 3
(Only for Dhyana)

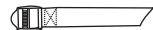

PADDLE

Paddle (excluded from Race/Hyper/Rapid/Super Trip/Mega/Airship Race/Blade/
Wave/Peace/Super Trip Tandem)

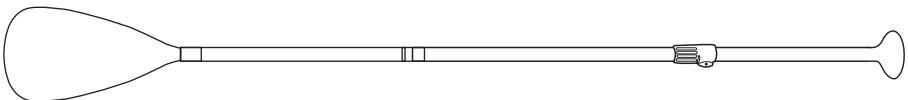

INSTRUCTION FOR ASSEMBLING AND DISASSEMBLING

A

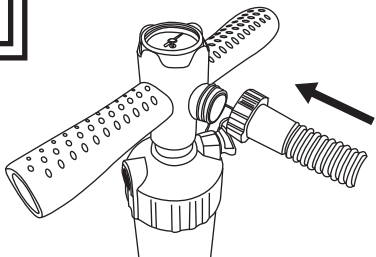

Pump Set Up And Inflation

Connect the pump hose to the gauge housing and secure it tightly.

B

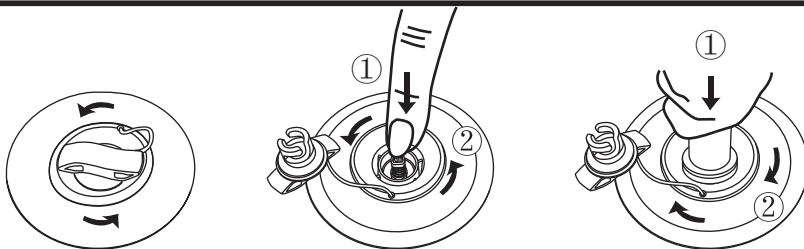

1. Open the valve cap by twisting counter-clockwise. Ensure the valve is clear from debris, sand, or dirt before releasing.
2. Push valve button in and turn counter-clockwise 90 degrees so it pops up and is in the "OUT" position.
3. Insert the pump hose and twist it 45 degree clockwise to lock in place. Inflate until you reach the required pressure.



12PSI minimum (8PSI for MEGA/ 10PSI for HYPER inner chamber) for proper inflatable boards operation and 15PSI maximum (18PSI for SUPER TRIP TANDEM/ RAPID/ RACE/ WAVE/ BLADE/ AIRSHIP RACE). Over inflation will void your warranty.

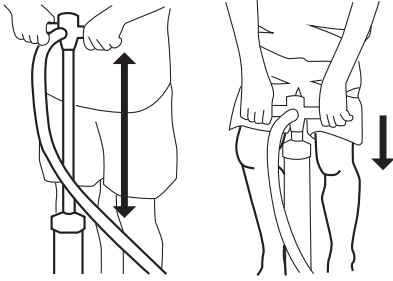

Inflate Faster With Less Effort

- Use full range of the pump cylinder while keeping your arms extended.
- Bend your knees and use the body weight.

C

LIQUID AIR V1

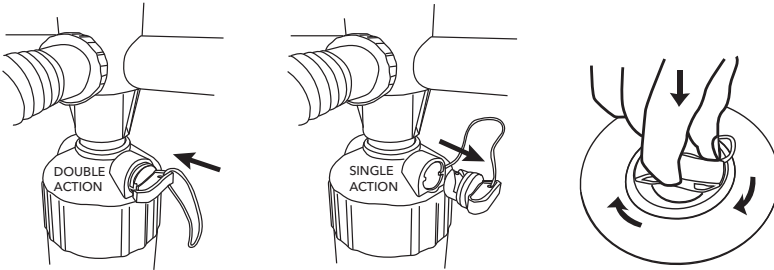

1. Use **DOUBLE ACTION** mode by closing the air-tap to pump the board up to 7 psi.
2. Switch to **SINGLE ACTION** position by opening the air-tap to pump the board up to 15 - 18 psi.

LIQUID AIR V2

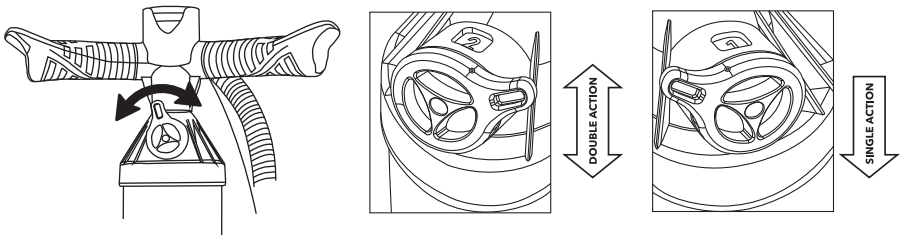

1. Use **DOUBLE ACTION** mode with the top cap displaying "2" to pump the board up to 7 - 10 psi.
2. Rotate the switch to **SINGLE ACTION** mode with the top cap displaying "1" to pump the board up to 15 - 18 psi.

After inflation, return the valve cover and tighten in clockwise direction to lock in place.

PRECAUTION & TIPS

- Electric Pumps can be used to inflate board up to 80-90%. However, the remaining pressure required should be achieved by using the hand pump to avoid over-inflation.
- Do not use air compressors as this voids warranty of board.
- Before long trips, ensure the board has been inflated and has maintained pressure for a minimum of 24 hours.

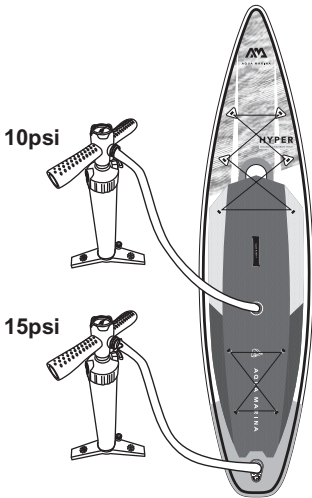

For Double Chamber Board

For best performance, the double chamber should always be inflated to ensure the highest stiffness and safety.

- Inflate the inner chamber up to 10 PSI.
- Inflate the outer chamber up to 15 PSI.

D

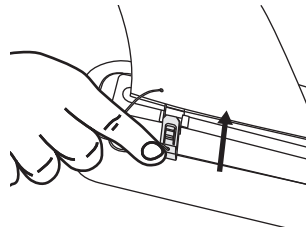
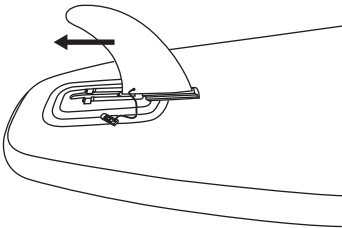

Slide-in Center Fin Installation

Once the board is inflated, slide in the large Center Fin to the fin base and insert the push-in pin.

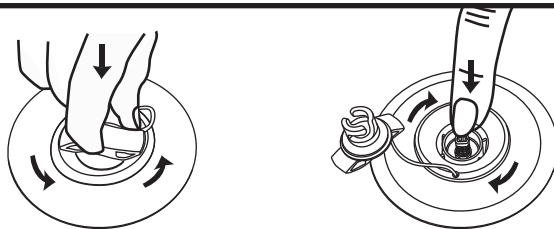
E

Deflation

To deflate your board, follow the instructions below.

1. Open the valve cap by twisting counter-clockwise. Ensure the valve is clear from debris, sand, or dirt before releasing.
2. Push valve button in and turn clockwise to lock it in DOWN position.

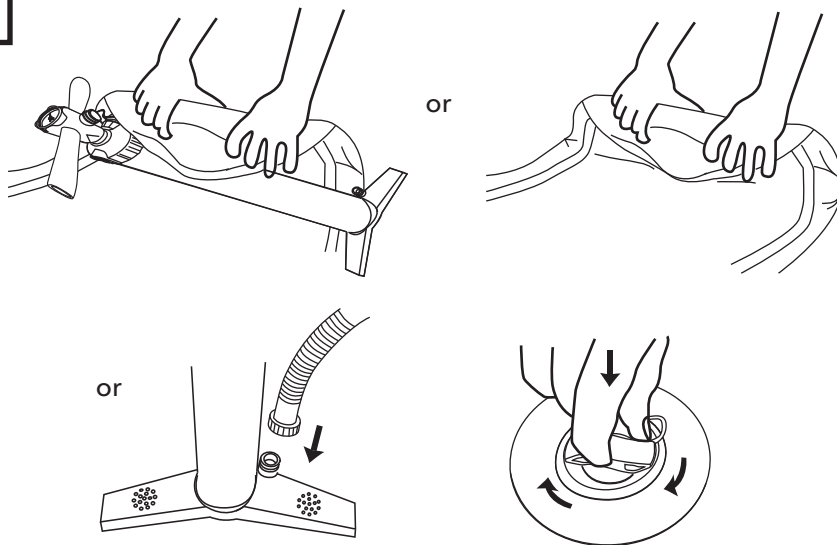
F

Folding Steps

1. We recommend rolling your board around the pump and pushing all air out as you roll. Alternatively, you can roll up your board from nose to tail, pushing out any remaining air as you roll, or use the pump on "deflate" position (for LIQUID AIR V1 only) for faster deflation.
2. Press all air out of the board; close the valve cap, and tighten in clockwise direction to lock in place.

NOTE:

For RACE board, we still recommend rolling your board around the pump. Alternatively, please fold in the dotted line as below (Fig. A) to avoid bending the side rail pads.

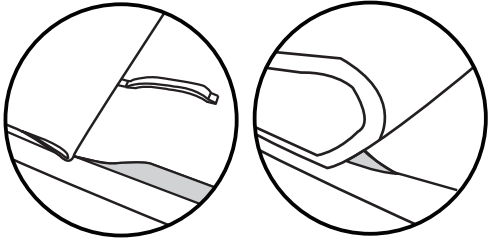

TIP:

Start to fold from here.

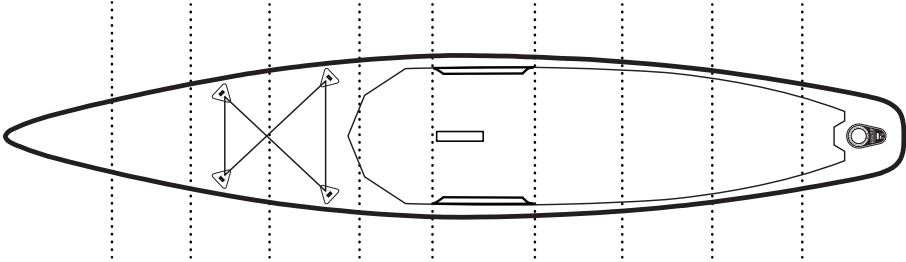
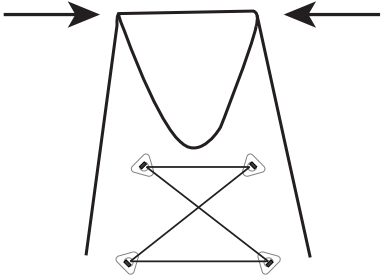

(Fig. A)

HOW TO REPAIR A CUT OR PUNCTURE IN YOUR INFLATABLE BOARD

G

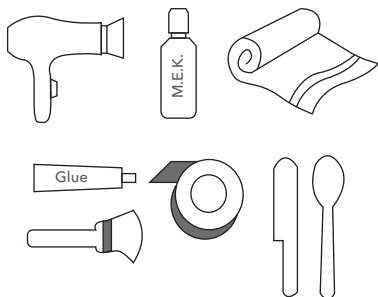

SUPPLIES REQUIRED

- Glue (AQUASEAL® is recommended)
- Acetone or methyl ethyl ketone (M.E.K.)
- Hairdryer
- Brush
- Tape
- Spatula or spoon
- Towel

(Not provided in the SUP board package)



1

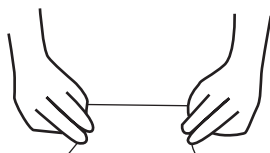

2

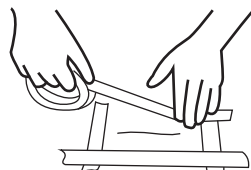

3

1. Clean the area around the cut or puncture using acetone or M.E.K.
2. Draw the outline of the patch using chalk or pencil (do not use ink).
Cut the patch, cover the cut or puncture with approximately 2.5cm (1 inch) overlap on all sides.
3. Apply tape along the outline of the patch. This will prevent the glue from spreading outside the patch area.

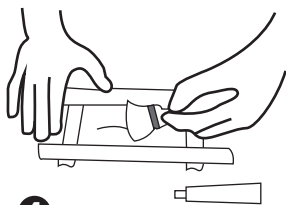

4

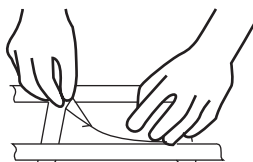

5

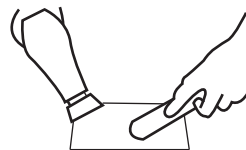

6

4. Apply glue on both the board and patch using a brush or other applicator. Make sure the glue is spread evenly and completely over the board and patch. Let the glue dry for 5 minutes.

5. Apply the patch starting on one side and move towards the other side
Be careful not to trap any air bubbles.
6. Use a hairdryer to gently heat the area to ensure a good bond between the patch and the board.

Use a metal spatula or spoon and firm pressure to ensure a good bond and to remove any air bubbles.

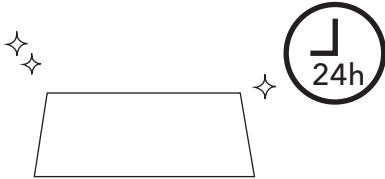

Allow the glue to cure with the board un-inflated for 24 hours prior to use.

HOW TO FIX A LEAKING VALVE

H

A. Try to tighten the valve

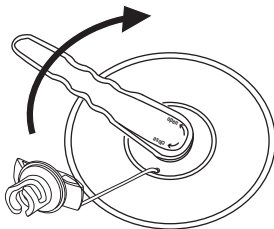

1. Inflate your board up to the max air pressure
2. Stick your valve wrench down inside of valve and turn clockwise to tighten the valve back down onto the board

B. Re-install or replace a valve

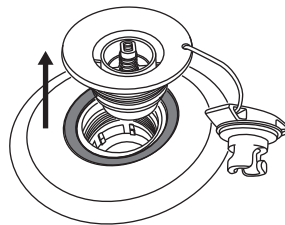
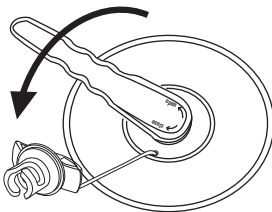

1. Completely deflate your board
2. Undo the dust cap and insert the valve wrench into the valve and twist counterclockwise to remove the valve

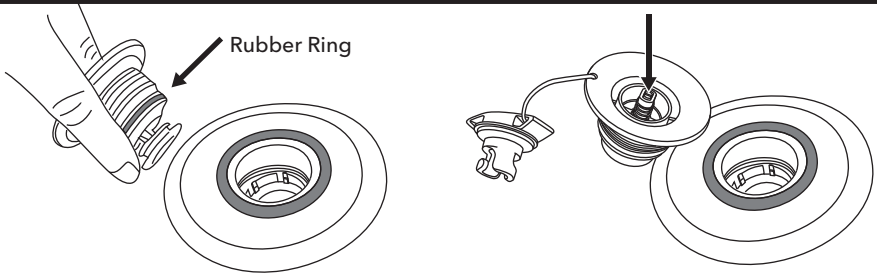

3. Check the rubber ring to make sure that it is in the correct position, tight around the valve and there is no debris in the way
4. Be sure the pin spring is functioning properly and that there are no cracks along the edges

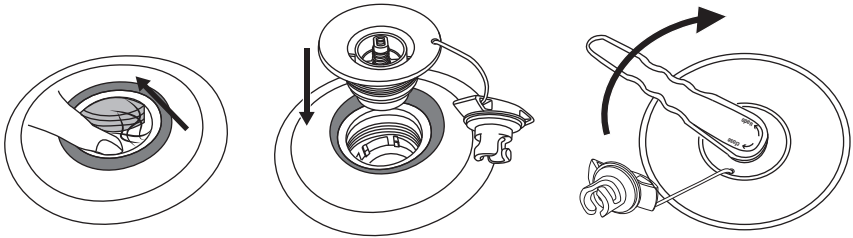

5. Ensure there are no strings from the drop stitching material
6. Note the bottom piece of the valve is not attached to anything
7. Fit the valve back into your board
8. Align all the threads and twist to tighten
9. Once the valve is hand tight, use the valve wrench to seal completely



NOTE: Correctly use the wrench by pressing it with one hand on top.

PADDLE ASSEMBLY

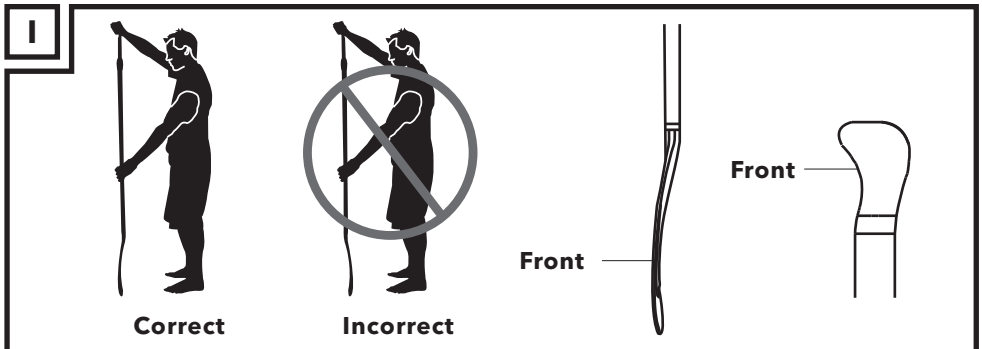

Aqua Marina 3-piece adjustable shaft uses a secure spring pin system and comes with an additional clamp to reduce any play.

SECURE SPRING PIN

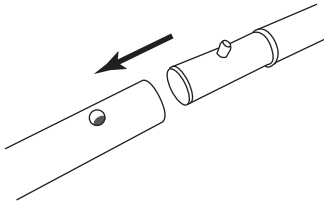

CLAMP SYSTEM FOR ALUMINUM SHAFT

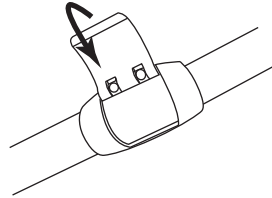

CLAMP SYSTEM FOR CARBON and FIBERGLASS SHAFT

Easily adjust the level of tightness by rotating the hasp to avoid any play.

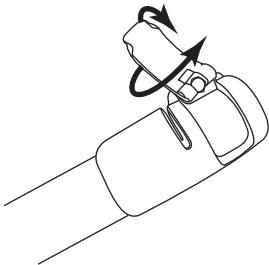

Ensure the center line of the scale is aligned with the indicator on clamp

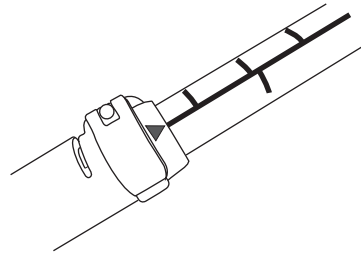

NOTE: Always drain the water left in the paddle shaft after each use.

3 PCS ADJUSTABLE

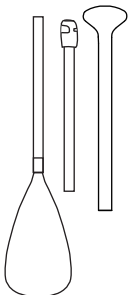

- **SPORTS III** B0303012
Adjustable Aluminum iSUP Paddle
- **SOLID** B0303013
Adjustable Fiberglass iSUP Paddle
- **CARBON GUIDE** B0303014
Carbon / Fiberglass iSUP Paddle
- **CARBON PRO** B0303015
Carbon iSUP Paddle

2 PCS ADJUSTABLE

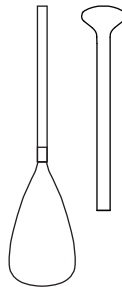

- **CARBON X** B0303016
2-section Carbon iSUP Paddle

2-IN-1

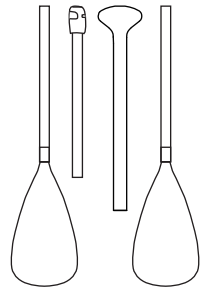

- **DUAL-TECH** B0303011
2-in-1 iSUP & Kayak Paddle

HOW TO WEAR A SAFETY LEASH

WAIST



RIVER LEASH
B0303025

ANKLE



COIL LEASH
B0303023



SURF LEASH
B0303024



STANDARD LEASH
B0302765

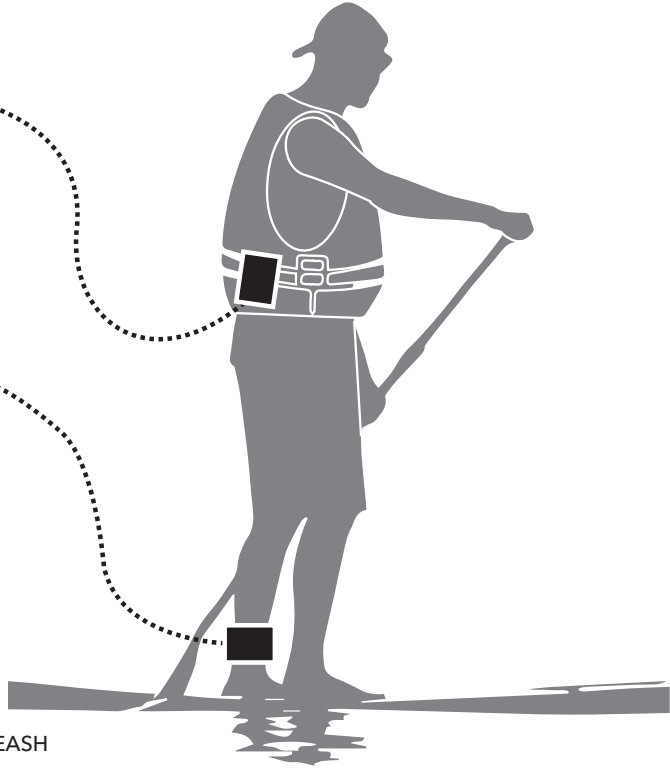

STANDARD LEASH INSTALLATION

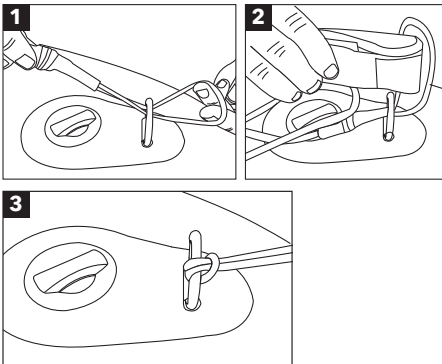

COIL/SURF/RIVER LEASH INSTALLATION

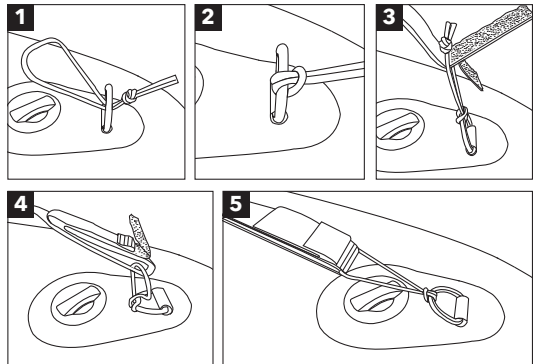

FAQs (Frequently Asked Questions)

Q: How much air should I pump into my board, and how long does it take to inflate?

A: The maximum pressure is 15 - 18 PSI (8 PSI for MEGA, 10 PSI for HYPER inner chamber), any higher you risk over inflating and damage. Depending on the size of your board it can take anywhere from 5 to 8 minutes.

Q: When detaching the pump from the board, the air starts to release from the valve. How do I stop this from happening?

A: The air is releasing as the valve spring pin has been left in the deflating position. Simply push down and turn the pin until it lifts up into the inflation position and stops air from releasing; continue to inflate the board until up to pressure.

Q: Can I leave my board inflated in the sun and over night?

A: If leaving the board inflated, we strongly recommend you to remove it from direct sunlight and deflate the board at least to 10PSI (5PSI for MEGA).

Q: How should I clean and how should I store my board?

A: We only recommend water and a mild soap. Heavy detergents and solvents can damage your board. It is best to clean and dry your board, take out the fins, roll it up and put in the bag.

Q: If I puncture my board, can I repair by myself?

A: Yes, you can use the required tools listed in the manual with the supplied repair kit or email us for more information at info@aquamarina.com.

WARRANTY

**1
YEAR**

AM warrants this product to be free from major defects in material or workmanship to the original purchaser for a period of one (1) Year from the date of purchase. This warranty is subject to the following limitations

1. The warranty is valid only when this product is used for normal recreational activities and does not cover products used in rental or school operations.
2. AM will make the final warranty determination, which may require inspection and/or photos of the equipment, which clearly show the defect(s). If necessary, this information must be sent to the AM distributor in your country with prepaid postage. Product can be returned only if a return authorization number is given in advance by the AM distributor. The return authorization number must be clearly labelled on the outside of the package, or it will be refused.
3. If a product is deemed to be defective by AM, the warranty covers the repair or replacement of the defective product only. AM will not be responsible for any costs, losses, or damages incurred as a result of loss or misuse of this product.
4. This warranty does not cover damage caused by misuse, abuse, neglect, normal wear and tear including, but not limited to punctures, damage due to excessive heat exposure, damage caused by improper handling and storage, damage caused by use in waves or shore break, board breakage caused by filling or crashing in surf conditions, or damage caused by anything other than defects in material and workmanship.
5. This product must not be modified and/or fitted with a motor except AM BlueDrive power fin.
6. This product must not be used in excess of the manufacturers recommended maximum load capacity.
7. This warranty is void if any unauthorized repair, change or modification has been made to any part of the equipment.
8. The warranty for any repaired or replacement equipment is good from the date of the original purchase only.
9. The original purchase receipt must accompany all warranty claims. The name of the retailer and date of purchase must be clear and legible.
10. There are no warranties that extend beyond the warranty specified here in.



WARNING

This product is designed in accordance with standards for a specific use. Any modifications or transformations higher than that indicated by the manufacturer could result in serious risks for the user and will void the warranty.

FR

Art.Nr. 3015908

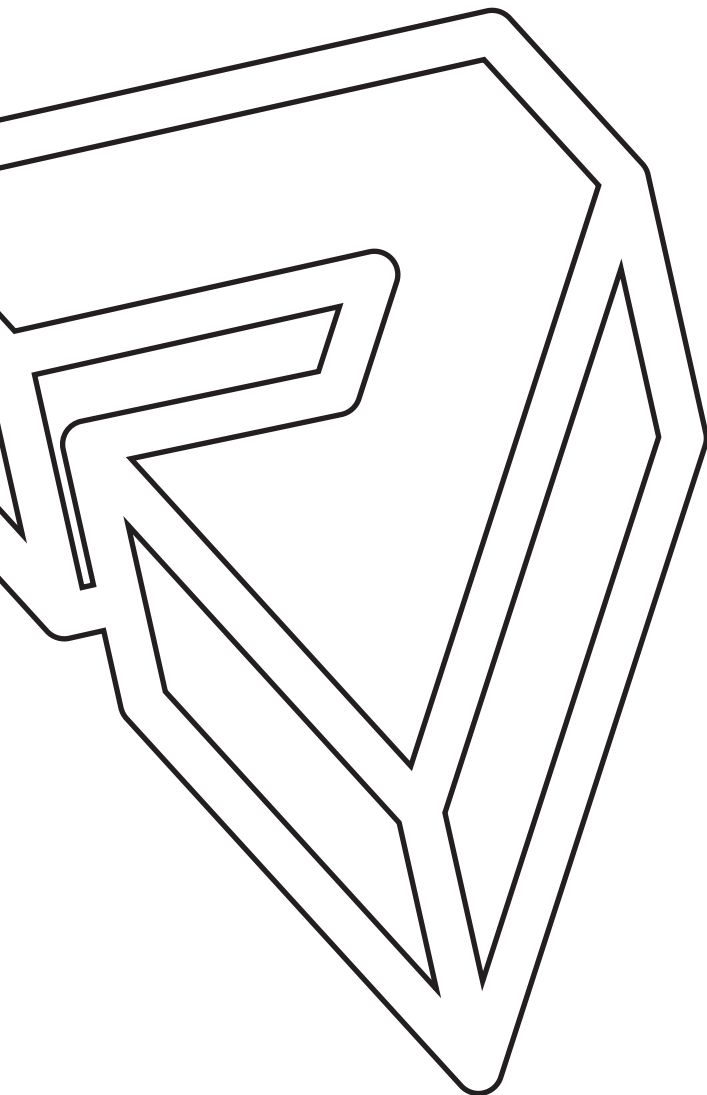

AQUA MARINA

2021

GONFLABLE

PLANCHE DE STANDUP PADDLE
MANUEL DE L'UTILISATEUR



ATTENTION

Pour votre propre sécurité et celle de votre équipement, assurez-vous de prendre les précautions suivantes. Le non-respect des avertissements et des instructions peut entraîner des dommages matériels, des blessures graves ou la mort.

INFORMATIONS GÉNÉRALES D'UTILISATION

Ce manuel a été conçu pour vous aider à utiliser votre planche gonflable de stand up paddle (ci-après dénommé ISUP) avec sécurité et plaisir. Il contient des détails de l'ISUP, les équipements fournis, et des informations sur leur fonctionnement. Veuillez le lire attentivement afin de vous familiariser avec l'ISUP avant de l'utiliser.

SÉCURITÉ

Il y a un risque de blessure grave ou de mort par noyade. Les sports de pagaie peuvent être très dangereux et très exigeants physiquement. L'utilisateur de ce produit reconnaît, comprend et assume les risques liés aux sports de pagaie. Veuillez respecter les étiquettes d'avertissement et les normes de sécurité suivantes lorsque vous utilisez ce produit.



aquamarina.com

AVERTISSEMENT INSTRUCTIONS SUR L'ÉTIQUETTE



INSTRUCTIONS OBLIGATOIRES

- Porter un vêtement de flottaison individuel
- Lire les instructions en premier
- Gonfler complètement toutes les chambres à air
- Nombre d'utilisateurs
- Max. capacité de chargement
- Distance de sécurité à la rive 150 m (492.1pi)



INSTRUCTION INTERDITES

- Ne pas utiliser en eau vive (sauf BT-20RP)
- Ne pas utiliser dans les vagues déferlantes (sauf BT-20WA)
- Ne pas utiliser avec courant au large
- Ne pas utiliser dans le vent au large
- Non destinée aux enfants de 14 ans et au dessous (sauf BT-19VIP)



AATTENTION / DANGER / AVERTISSEMENT

- Conception pression de fonctionnement
- Pas de protection contre la noyade



INSTRUCTIONS OBLIGATOIRES

- Nageurs seulement
- Surveillez toujours les enfants dans l'eau





CN-ORP





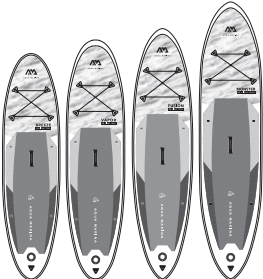

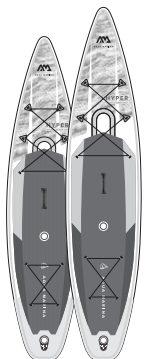
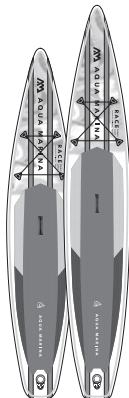

Item No.:

Oriental Recreational Products (Shanghai) Co., Ltd.
1699 Daye Road, Fengxian Shanghai, China 201402

NUMERO DE SÉRIE

- Numéro d'article
- Informations sur le fabricant

TOUT ALLER								TOURING		COURSES		RIVIÈRE
												
MODÈLE												
BREEZE	VAPOR	FUSION	MONSTER	CORAL	BEAST	MAGMA	ATLAS	HYPER	HYPER	RACE	RACE	RAPID
BT-21BRP	BT-21VAP	BT-21FUP	BT-21MOP	BT-21COP	BT-21BEP	BT-21MAP	BT-21ATP	BT-21HY01	BT-21HY02	BT-21RA01	BT-21RA02	BT-20RP
TAILLE												
9'10"	10'4"	10'10"	12'0"	10'2"	10'6"	11'2"	12'0"	11'6"	12'6"	12'6"	14'0"	9'6"
30"	31"	32"	33"	31"	32"	33"	34"	31"	32"	27"	27"	33"
4.7"	6"	6"	6"	4.7"	6"	6"	6"	6"	6"	6"	6"	6"
300 cm	315 cm	330 cm	366 cm	310 cm	320 cm	340 cm	366 cm	350 cm	381 cm	381 cm	427 cm	289 cm
76 cm	79 cm	81 cm	84 cm	78 cm	81 cm	84 cm	86 cm	79 cm	81 cm	69 cm	69 cm	84 cm
12 cm	15 cm	15 cm	15 cm	12 cm	15 cm	15 cm	15 cm	15 cm	15 cm	15 cm	15 cm	15 cm
AILERON												
1 PALME CETER				1 PALME CETER				1 PALME DE COURSE		1 PALME DE COURSE		1 PALME DE RIVIÈRE + 4 PALME FIXES
VOLUME												
220 L	310L	320L	380L	230L	300L	330L	390L	330L	370L	320L	360L	300L
POIDS MAXIMUM DE L'UTILISATEUR												
220 LBS	308LBS	330LBS	374LBS	231LBS	308LBS	330LBS	396LBS	330LBS	374LBS	330LBS	352LBS	286LBS
100 KG	140KG	150KG	170KG	105KG	140KG	150KG	180KG	150KG	170KG	150KG	160KG	130KG
PRESSIION MAXIMALE DE L'AIR												
15 PSI				15 PSI				15 PSI / 10 PSI (chambre centrale)		18 PSI		18 PSI

SURF	VOILE	MULTI-PERSONNE				FITNESS	PÊCHE		ENFANT
						<p>Yoga Dock BT-19YD Diamètre extérieur: 290cm/9'6" Diamètre intérieur: 170cm/67" Épaisseur: 12cm/4.7"</p> 			
WAVE BT-20WA	BLADE BT-20BL	SUPER TRIP BT-21ST01	SUPER TRIP TANDEM BT-20ST02	MEGA BT-20ME	AIRSHIP RACE BT-20AS	PEACE BT-20PC	DHYANA BT-21DHP	DRIFT BT-20DRP	VIBRANT BT-19VIP
8'8" 30" 4"	10'6" 33" 4.7"	12'2" 32" 6"	14'0" 34" 6"	18'1" 60" 8"	22'0" 34" 8"	8'2" 35" 6"	11'0" 36" 6"	10'10" 38" 6"	8'0" 28" 4"
265 cm 75 cm 10 cm	320 cm 84 cm 12 cm	370 cm 82 cm 15 cm	427 cm 86 cm 15 cm	550 cm 152 cm 20 cm	670 cm 87 cm 20 cm	250 cm 90 cm 15 cm	336 cm 91 cm 15 cm	330 cm 97 cm 15 cm	244 cm 71 cm 10 cm
1 PALME CETER	1 PALME DAGGER + 1 PALME CENTRE	1 PALME CETER	2 PALME CETER	5 PALME CETER	1 PALME DE COURSE	/	1 PALME CETER	1 PALME CETER	1 PALME CETER
165L	280L	400L	500L	1400L	1000L	340L	360L	284L	140L
209LBS 95KG	264LBS 120KG	462LBS 210KG	507LBS 230KG	1433LBS 650KG	1014LBS 460KG	330LBS 150KG	352LBS 160KG	286LBS 130KG	132LBS 60KG
18 PSI	18 PSI	15 PSI	18 PSI	8 PSI	18 PSI	15 PSI		15 PSI (panneau) / 3PSI (chambres à air latérales)	15 PSI

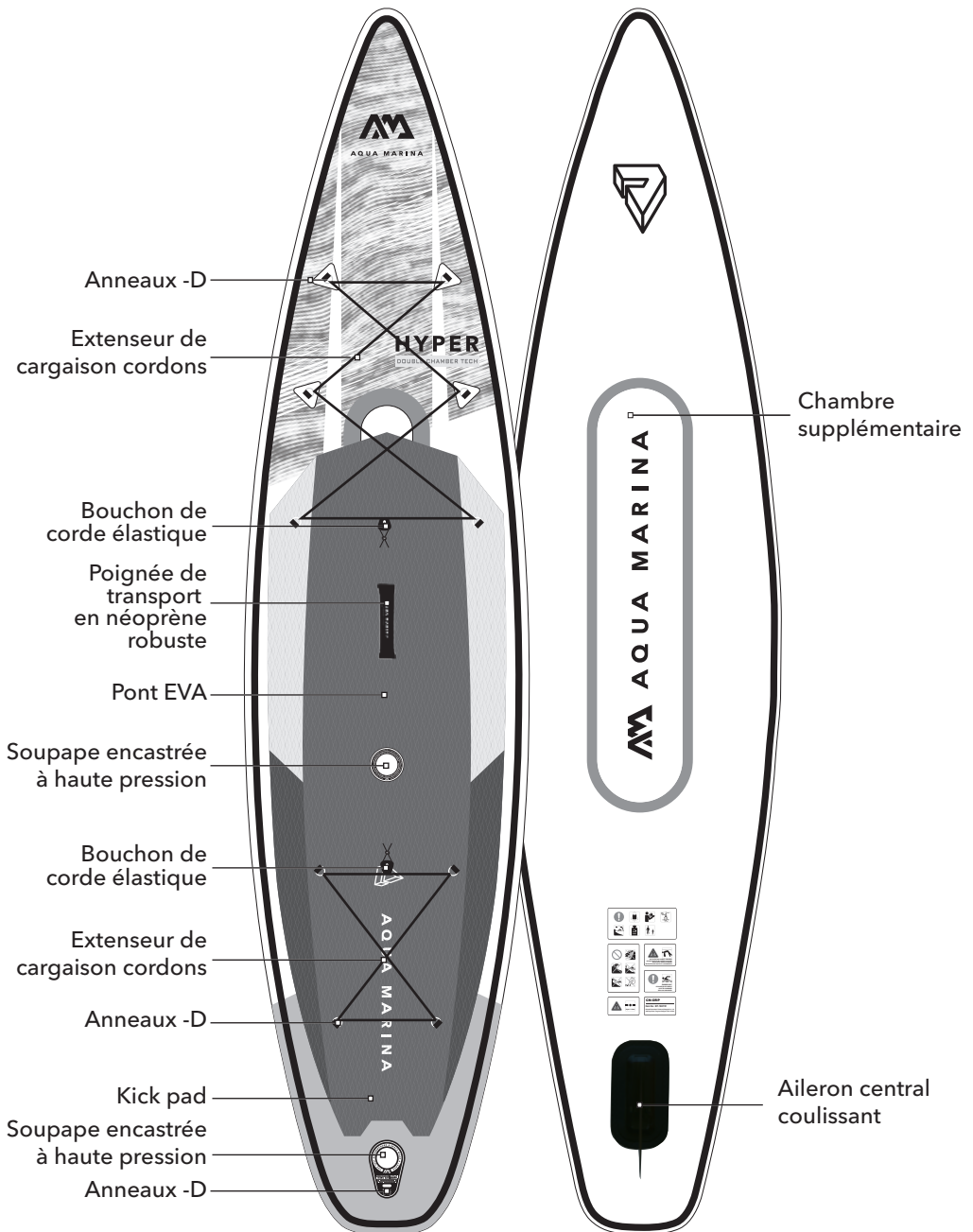

La configuration réelle peut varier selon les modèles.

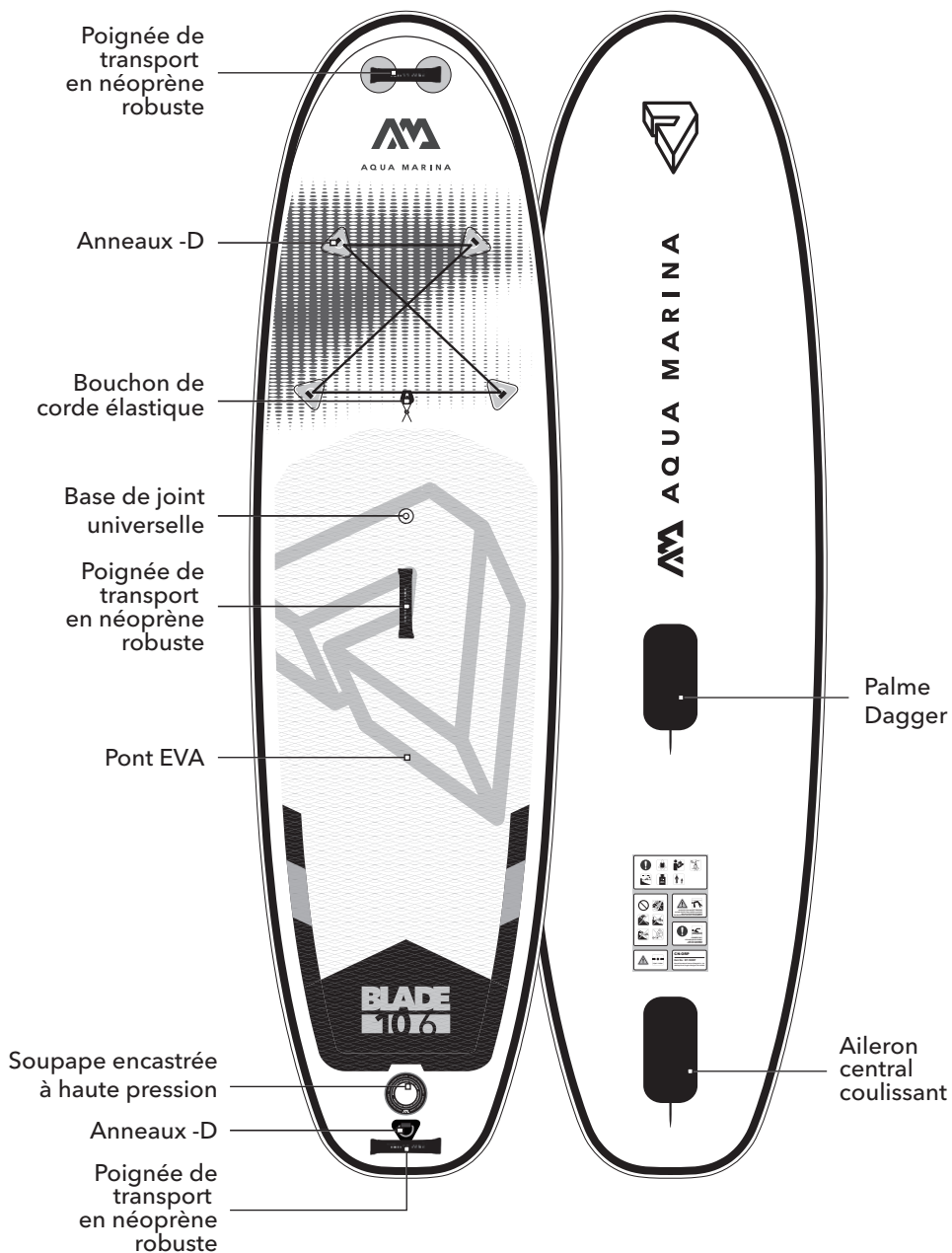

La configuration réelle peut varier selon les modèles.

ACCESSOIRES

STANDARD

Sac à dos zippé

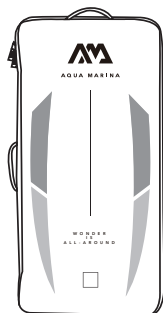

Pompe double-Action -
LIQUID AIR V1

(Mega/Airship Race/ Super Trip Tandem x 2)
(Coral/Beast/Magma/Atlas/Hyper/Race
est livré avec LIQUID AIR V2)

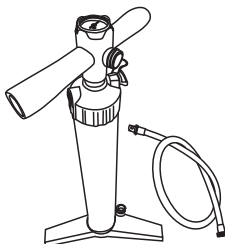

Aileron central coulissant

(Mega x 5 /
Super Trip Tandem x 2)



Cordon cargo

(sauf Wave) (Hyper x 2)



Kit de réparation



Laisse

(sauf Super Trip/ Super Trip Tandem/Mega/
Airship Race/Peace/Yoga Dock)

DRIFT

Porte-canne à pêche x 2

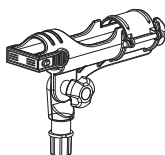

Porte-palette

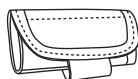

MEGA/YOGA DOCK

Carry Bag



CORAL/YOGA

Sangle de bord



Porte-palette

(Uniquement pour Dhyana)



Sangles x 3

(Uniquement pour Dhyana)

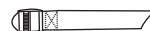

PAGAIÉ

Pagaie (sauf Race/Hyper/Rapid/Super Trip/Mega/Airship Race/Blade/
Wave/Peace/Super Trip Tandem)

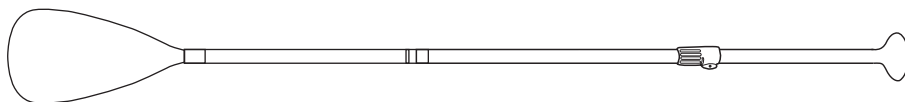

INSTRUCTION D'ASSEMBLAGE ET DE D ÉMONTAGE

A

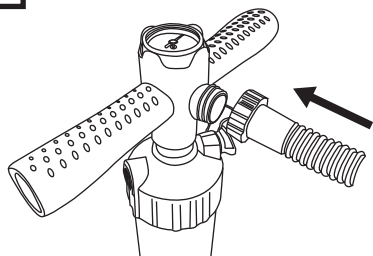

Mise en place de la pompe et gonflage

Connectez le tuyau de la pompe
au boîtier de la jauge et fixez-le
fermement.

B

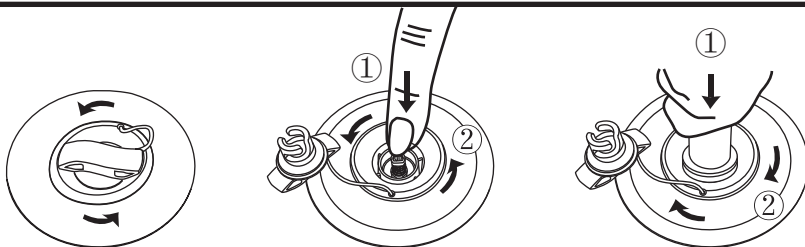

1. Libérez le couvercle de la vanne en le tournant dans le sens inverse des aiguilles d'une montre. Assurez-vous que la vanne n'a pas de sable ou de saleté avant de le relâcher.
2. Appuyer sur le bouton de la vanne et tourner de 90 degrés dans le sens inverse des aiguilles d'une montre pour qu'il sorte et qu'il soit dans la position
3. Insérez le tuyau de la pompe et tournez-le de 45 degrés dans le sens des aiguilles d'une montre pour le verrouiller et le mettre en place. Gonflez jusqu'à ce que vous atteigniez la pression requise.



**12PSI minimum (8PSI pour MEGA / 10PSI pour la
chambre intérieure HYPER) pour des planches
gonflables convenables fonctionnement et
15PSI maximum (18PSI pour SUPER TRIP
TANDEM/ RAPID/ RACE/ WAVE/ BLADE/ AIRSHIP
RACE). Surgonflage doit être évité pour la
garantie.**

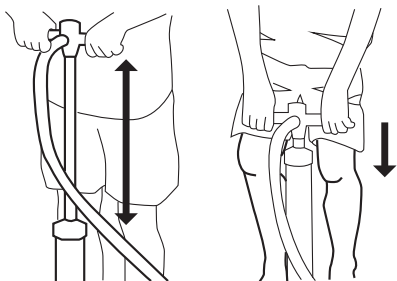

Gonflez plus vite avec moins d'effort

- Utilisez la gamme complète du cylindre de pompe tout en gardant vos bras étendus.
- Pliez les genoux et utilisez le poids de votre corps.

C

LIQUID AIR V1

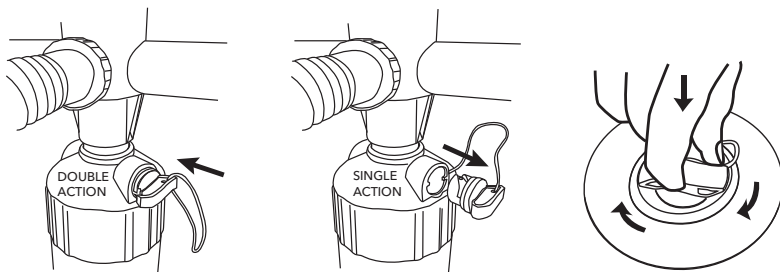

1. Utilisez le mode **DOUBLE ACTION** en fermant l'arrivée d'air pour pomper la planche jusqu'à 7 psi.
2. Passer à la position **ACTION UNIQUE** en ouvrant le robinet d'air pour pomper la planche jusqu'à 15 - 18 psi.

LIQUID AIR V2

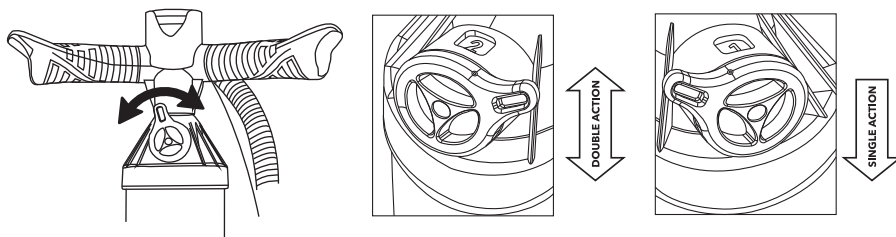

1. Utilisez le mode **DOUBLE ACTION**, avec le capuchon supérieur affichant "2", pour pomper la planche jusqu'à 7 - 10 psi.
2. Tournez le commutateur en mode **ACTION UNIQUE**, avec le capuchon supérieur affichant "1", pour pomper la planche jusqu'à 15 - 18 psi.

Après le gonflage, retournez le couvercle de la vanne et serrez dans le sens des aiguilles d'une montre pour la verrouiller en place.

PRÉCAUTION ET CONSEILS

- Les pompes électriques peuvent être utilisées pour gonfler une planche jusqu'à 80-90%. Pour le reste du gonflage, veuillez utiliser la pompe à main pour éviter le sur-gonflage.
- N'utilisez pas de compresseurs d'air car cela annule la garantie de la planche.
- Avant de longs trajets, assurez-vous que la planche a été gonflée et qu'elle a gardé la pression pendant au moins 24 heures.

10psi



15psi

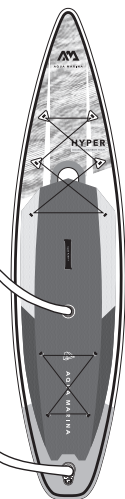

Pour la planche chambre double

Pour de meilleures performances, la chambre double doit toujours être gonflée pour assurer la meilleure rigidité une sécurité optimale.

- Gonflez la chambre intérieure jusqu'à 10 PSI.
- Gonflez la chambre extérieure jusqu'à 15 PSI.

D

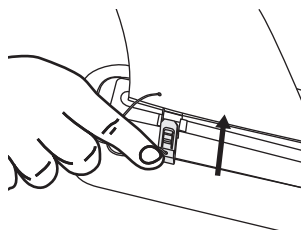
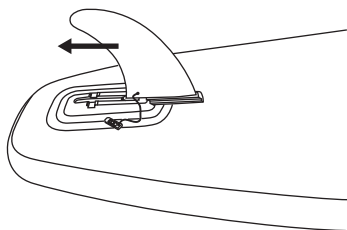

Installation de l'aileron central coulissant

Une fois la planche gonflée, glissez le grand aileron central à la base de l'ailette et insérez la goupille.

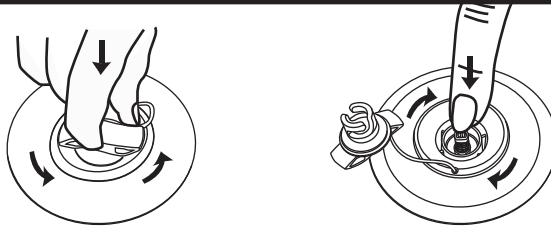
E

Dégonflage

Pour dégonfler votre planche, suivez les instructions ci-dessous.

1. Desserrer le capuchon de la valve en le tournant dans le sens inverse des aiguilles d'une montre. Assurez-vous que la valve n'a pas de sable ou de saleté avant de le relâcher.
2. Poussez le bouton de la valve vers l'intérieur et tournez dans le sens des aiguilles d'une montre pour le verrouiller en position BAS.

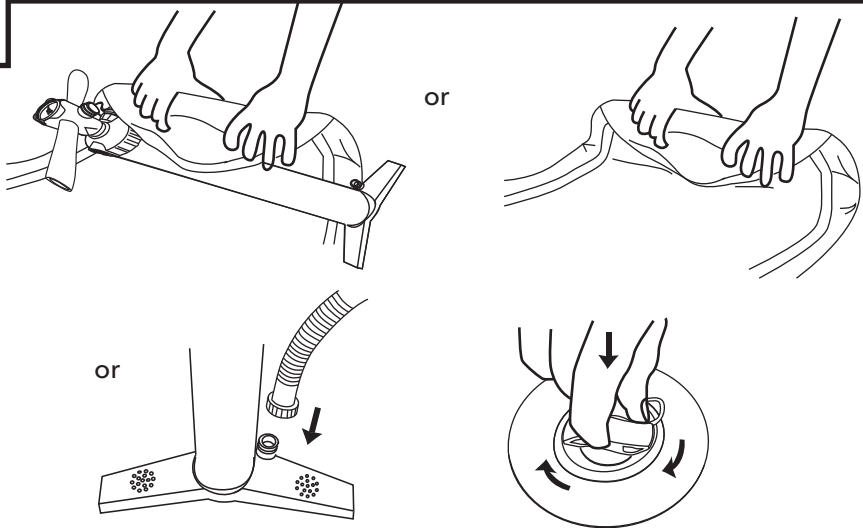
F

Étapes de pliage

1. Nous vous recommandons de faire tourner votre planche autour de la pompe et de faire sortir tout l'air pendant que vous faites tourner la planche. Vous pouvez également relever votre planche du nez à la queue, en expulsant tout l'air restant pendant que vous faites des roulades, ou utiliser la pompe en position "dégonflée" (pour LIQUID AIR V1 uniquement) pour un dégonflage plus rapide.
2. Extraire tout l'air de la planche, retourner le couvercle de la soupape et serrer dans le sens horaire pour le verrouiller en place.

REMARQUE :

Pour la planche RACE, nous vous recommandons encore de faire tourner votre planche autour de la pompe. Sinon, veuillez plier selon la ligne pointillée comme ci-dessous (photo A) pour éviter de déformer les coussinets des rails latéraux.

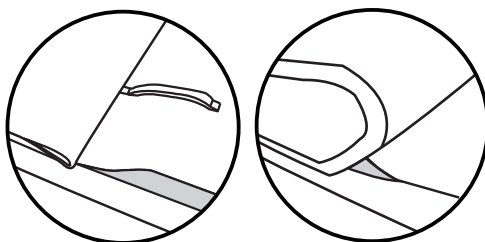

TIP:

Commencez à plier ici.

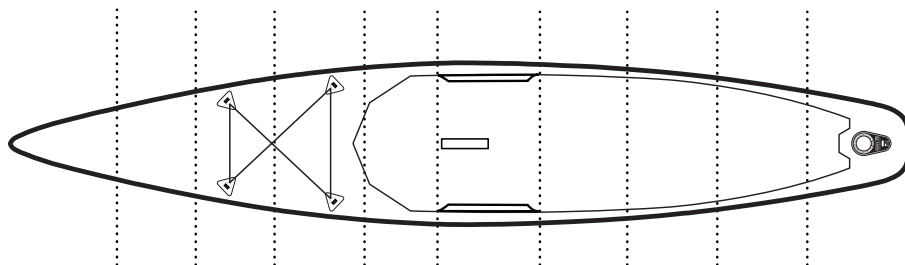
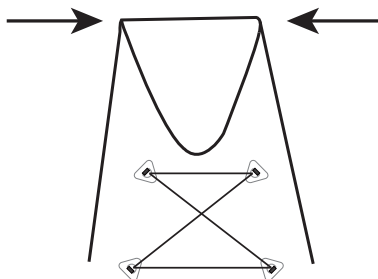

(Photo A)

COMMENT RÉPARER UNE COUPURE OU UN TROU DANS VOTRE PLANCHE GONFLABLE

G

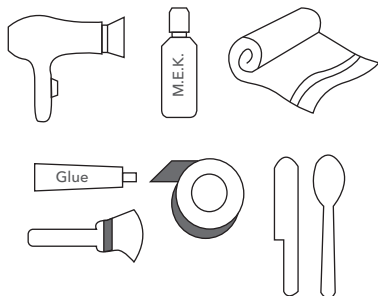

MATERIEL NECESSAIRE

- Colle (AQUASEAL® est recommandée)
- Acétone ou méthyléthylcétone (M.E.K.)
- Sèche-cheveux
- Brosse
- Ruban
- Spatule ou cuillère
- Serviette (Non fourni dans le package de la carte SUP)

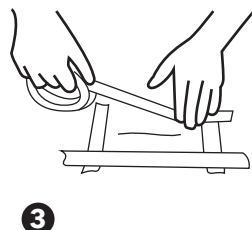
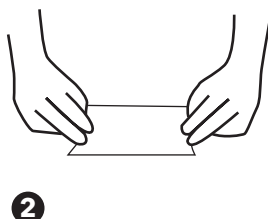

1. Nettoyez la zone autour de la coupure ou de la ponction en utilisant de l'acétone ou M.E.K
2. Dessinez le contour du patch à l'aide de craie ou d'un crayon (n'utilisez pas d'encre). Coupez le patch, couvrir la coupure ou le trou avec environ 2,5 cm (1 pouce) dépassant de tous les côtés
3. Appliquez du ruban le long du contour du patch. Cela empêchera la colle de se répandre à l'extérieur de la zone du patch.

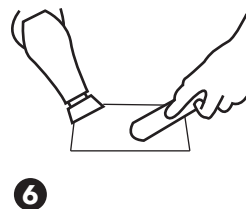
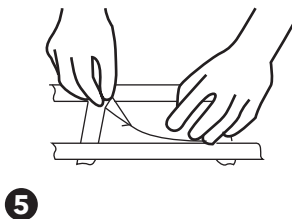
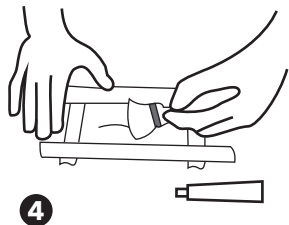

4. Appliquez de la colle sur le panneau et le patch en utilisant une brosse ou un autre applicateur. Assurez-vous que la colle est répartie uniformément et complètement sur la planche et le patch. Laissez

sécher la colle pendant 5 minutes.

5. Appliquez le patch en commençant d'un côté et en vous déplaçant vers l'autre côté tout en faisant attention à ne pas piéger des bulles d'air.
6. Utilisez un sèche-cheveux pour chauffer doucement la zone afin d'assurer une bonne liaison entre le patch et la planche. Utilisez une spatule en métal ou une cuillère et une forte pression pour assurer une bonne adhérence et éliminer les bulles d'air.

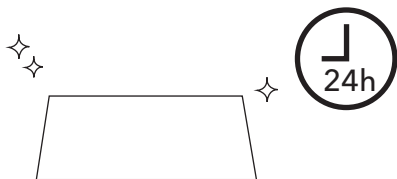

Laisser la colle sécher sur la planche non gonflée pendant 24 heures avant toute utilisation.

COMMENT RÉPARER UNE VALVE QUI FUIT

H

A. Essayez de serrer la valve

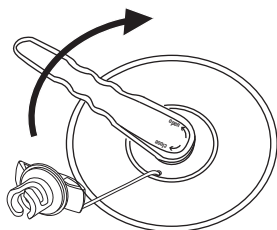

1. Gonflez votre planche jusqu'à la pression maximale
2. Collez votre clé à valve à l'intérieur de la valve en bas et tournez-la dans le sens des aiguilles d'une montre pour resserrer la valve sur la planche.

B. Réinstallez ou remplacez une valve

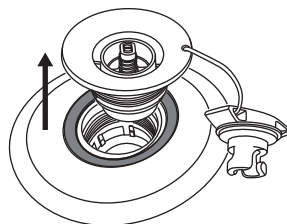
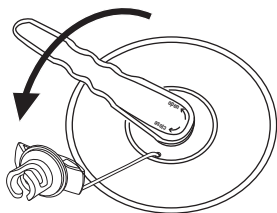

1. Dégonflez complètement votre planche
2. Dévissez le capuchon anti poussière et insérez la clé de à valve dans la valve et tournez-la dans le sens antihoraire pour retirer la valve

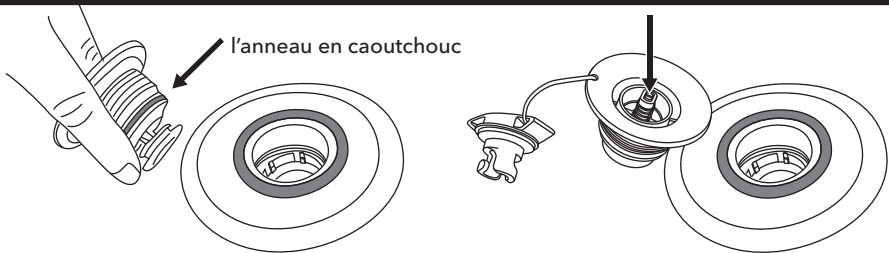

3. Vérifiez l'anneau en caoutchouc pour vous assurer qu'il est dans la bonne position, qu'il est serré autour de la valve et qu'il n'y a pas de débris sur son passage.
4. Assurez-vous que le ressort à goupille fonctionne correctement et qu'il n'y a pas de fissures sur les bords

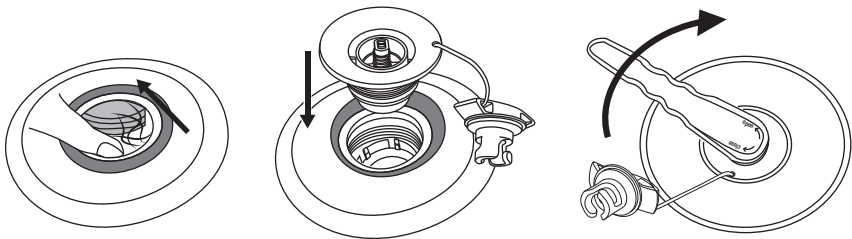

5. Assurez-vous qu'il n'y a pas de ficelles provenant de la couture du tissu.
6. Notez que la partie inférieure de la valve n'est pas attachée à quelque chose
7. Remettez la valve dans votre planche
8. Alignez tous les fils et faites-les tourner pour les serrer
9. Une fois que la valve est serrée à la main, utilisez la clé à valve pour la fermer à fond.



Utilisez la clé correctement en appuyant dessus avec la main.

ASSEMBLAGE DE LA PAGAIE

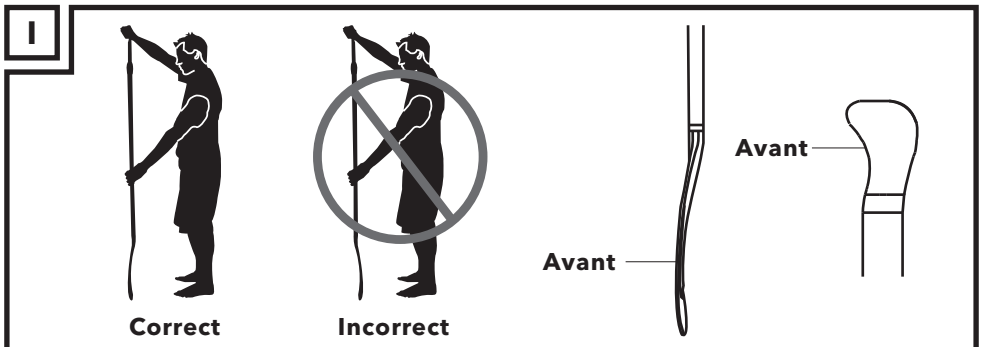

L'arbre réglable de 3 pièces Aqua Marina utilise un système de goupille à ressort, il est livré avec une pince supplémentaire pour réduire tout jeu.

FIXATION DE LA GOUPILLE ÉLASTIQUE

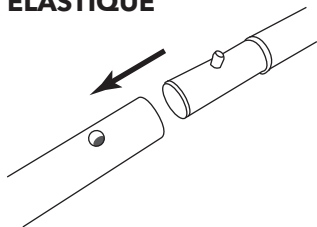

SYSTÈME DE SERRAGE POUR ARBRE EN CARBONE ET FIBRE DE VERRE

Ajustez facilement le niveau d'étanchéité en faisant tourner le loquet pour éviter tout jeu.

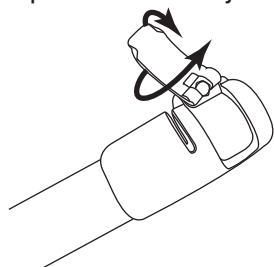

SYSTEME DE MANCHE ALUMINIUM

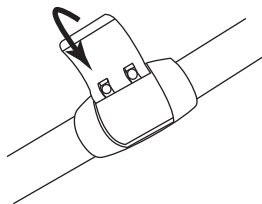

Assurez-vous que la ligne centrale de la balance est alignée avec l'indicateur de la pince

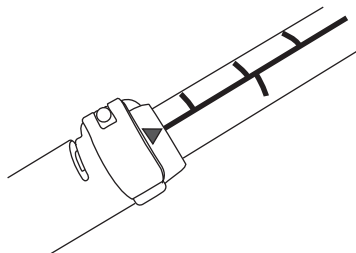

REMARQUE: Videz toujours l'eau qui reste dans la tige de la pagaie après chaque utilisation.

3 PIÈCES RÉGLABLES

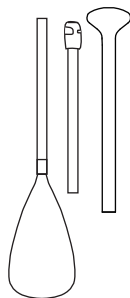

- **SPORTS III** B0303012
iSUP alu réglable pagaie
- **SOLID** B0303013
iSUP Fibre réglable pagaie
- **CARBON GUIDE** B0303014
iSUP carbone/fibres de verre pagaie
- **CARBON PRO** B0303015
Pagaie iSUP carbone

2 PIÈCES RÉGLABLES

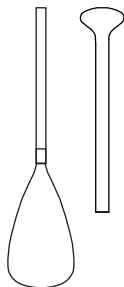

- **CARBON X** B0303016
Pagaie iSUP 2 parties en carbone

2-EN-1

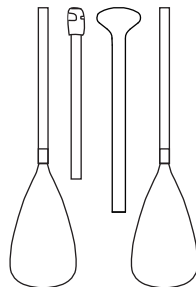

- **DUAL-TECH** B0303011
2-en-1 iSUP & pagaie de kayak

COMMENT PORTER UN LAASH DE SÉCURITÉ

TAILLE



LEASH EN RIVIÈRE
B0303025

CHEVILLE



LEASH BOBINE
B0303023



LEASH DE SURF
B0303024



LEASH STANDARD
B0302765

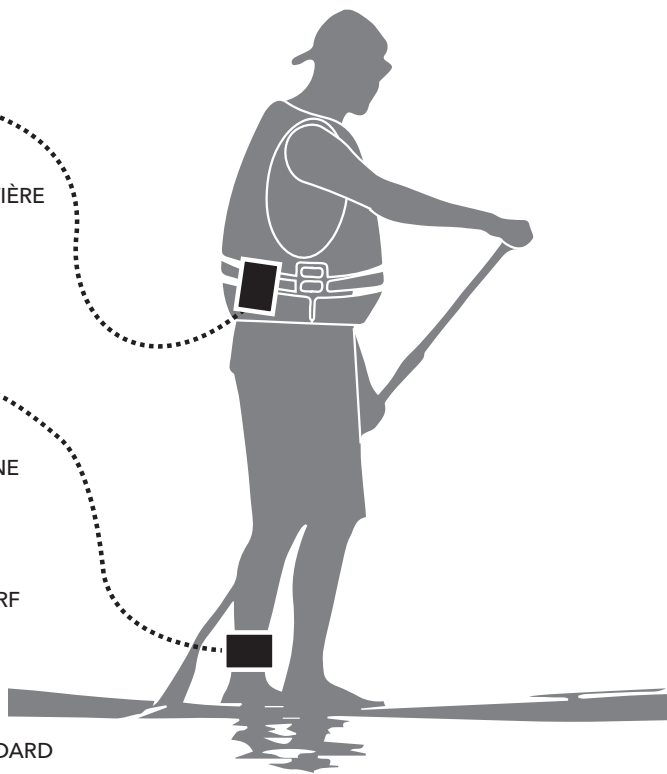

INSTALLATION DU LEASH STANDARD

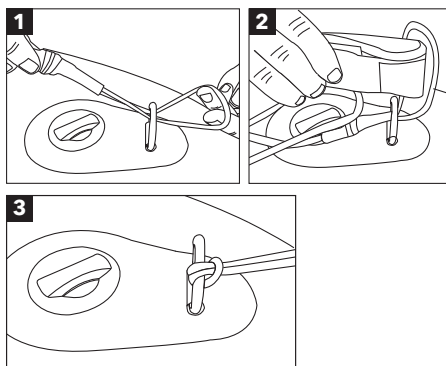

INSTALLATION LEASH EN RIVIÈRE/ SURF/BOBINE

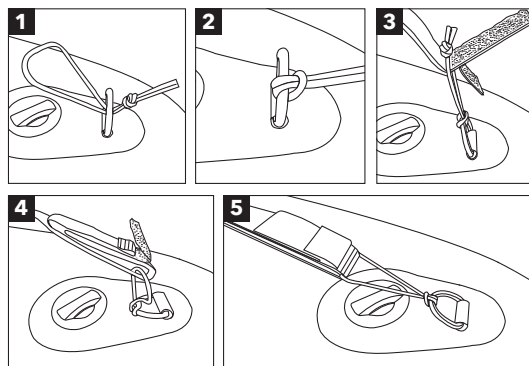

FAQ (Questions fréquemment posées)

Q: Quelle pression devrais-je injecter à ma planche et combien de temps faut-il pour gonfler ?

R: La pression recommandée est de 15 à 18 psi (8PSI pour MEGA, 10PSI pour la chambre intérieure HYPER), au-delà vous risquez de trop gonfler et provoquer des dommages. Selon la taille de votre planche, cela peut prendre de 5 à 8 minutes.

Q: Lorsqu'on détache la pompe de la planche, l'air commence à se dégager de la vanne. Comment puis-je empêcher cela de se produire?

R: L'air peut se dégager lorsque la goupille du ressort de la vanne a été laissée en position dégonflage. Poussez tout simplement vers le bas et tournez la goupille jusqu'à ce qu'elle se soulève et se place en position de gonflage et empêche ainsi l'air de sortir; continuez à gonfler la planche jusqu'à la pression maximale.

Q: Puis-je laisser ma planche gonflée au soleil ?

R: Si vous laissez la planche gonflée, nous vous recommandons fortement de ne pas l'exposer à la lumière directe du soleil et de la dégonfler à au moins à 10PSI (5PSI pour MEGA).

Q: Comment dois-je nettoyer et comment dois-je stocker ma planche?

R: Nous recommandons d'utiliser uniquement de l'eau et un savon doux. Les détergents lourds et les solvants peuvent endommager votre planche. Il est préférable de nettoyer et de sécher votre planche, de retirer les ailerons, de l'enrouler et de la mettre dans le sac.

Q: Si je perfore ma planche, est-ce que je peux la réparer moi-même?

R: Oui, vous pouvez utiliser les outils requis répertoriés dans le manuel avec le kit de réparation ou bien vous pouvez nous envoyer un courriel pour plus d'informations à info@aquamarina.com.

GARANTIE

1
AN

AM garantit à l'acheteur original que ce produit est exempt de défauts majeurs de main d'œuvre pour une période d'un (1) an à partir de la date d'achat. Cette garantie est soumise aux limitations suivantes:

1. La garantie est valide seulement lorsque ce produit est utilisé pour des activités récréatives normales et elle ne couvre pas les produits utilisés en cas de location ou pour un apprentissage.
2. AM pourra fixer une détermination finale de la garantie, ce qui peut nécessiter une inspection et / ou des photos de l'équipement, qui montrent clairement le (s) défaut(s). Si nécessaire, cette information doit être envoyée au distributeur AM de votre pays avec l'affranchissement prépayé. Le produit ne pourra être retourné que si un numéro d'autorisation de retour est donné à l'avance par le distributeur AM. Le numéro d'autorisation de retour doit être clairement indiqué à l'extérieur du colis, sinon le produit sera refusé.
3. Si un produit est jugé défectueux par AM, la garantie couvre uniquement la réparation ou le remplacement du produit défectueux. AM ne sera pas responsable des coûts, pertes ou dommages subis à la suite d'une perte ou d'une mauvaise utilisation de ce produit.
4. Cette garantie ne couvre pas les dommages causés par une mauvaise utilisation, abus, négligence, usure normale y compris, les crevaisons, les dommages dus à une exposition excessive à la chaleur, les dommages causés par une manipulation et un stockage inadéquats, les dommages causés par une utilisation au milieu de vagues ou shore break rives, en cas de dégradations de la planche causée par le remplissage ou la dégradation dans des conditions de surf, ou les dommages causés par autre chose que des défauts de matériaux et de fabrication.
5. Ce produit ne doit pas être modifié et / ou équipé d'un moteur sauf l'ailette de puissance AM BlueDrive
6. Ce produit ne doit pas être utilisé en dépassant la capacité de charge maximale recommandée par le fabricant.
7. Cette garantie est nulle si une réparation, modification ou modification non autorisée a été faite à n'importe quelle partie de l'équipement.
8. La garantie pour tout équipement réparé ou de remplacement est recevable uniquement à compter de la date de l'achat original.
9. Le reçu d'achat original doit accompagner toutes les demandes de garantie. Le nom du détaillant et la date d'achat doivent être clairs et lisibles.
10. Il n'existe aucune garantie autre que celle spécifiée ici.



ATTENTION

Ce produit est conçu conformément aux normes pour un usage spécifique. Toute modification ou transformation importante autre que celle indiquée par le fabricant peut entraîner des risques sérieux pour l'utilisateur et annule la garantie.

ES

Art.Nr. 3015908

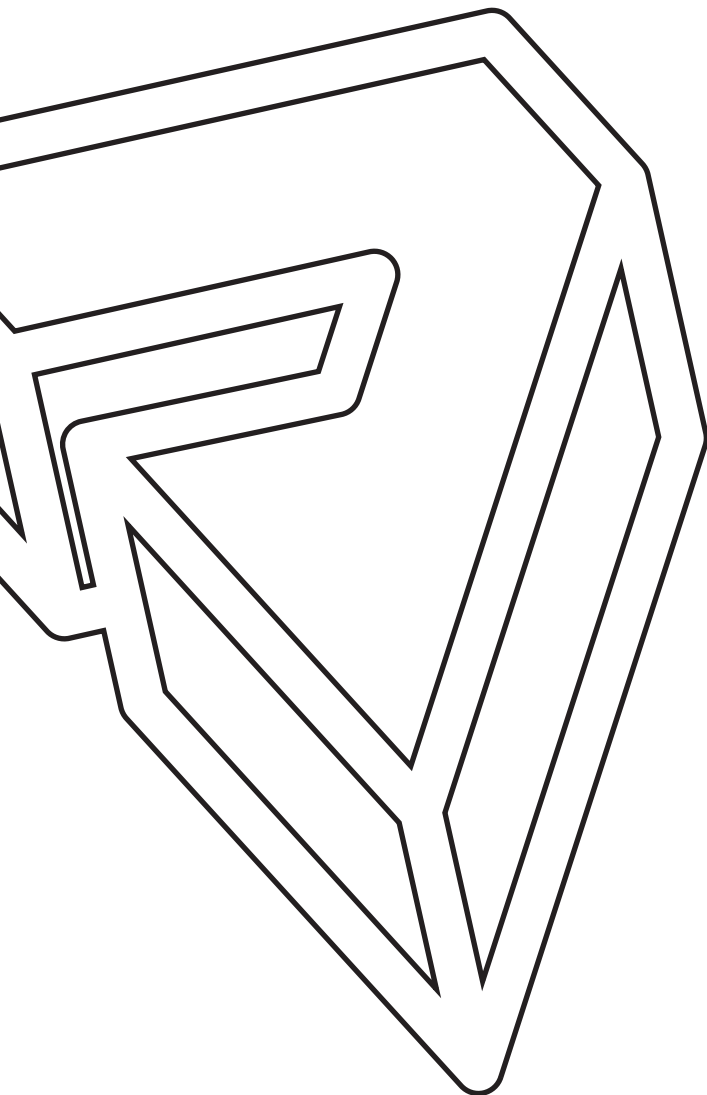

AQUA MARINA

2021

INFLABLE

STANDUP PADDLE BOARD

Manual de Usuario



ADVERTENCIA

Para su propia seguridad y la de su equipo, siga las siguientes precauciones. No seguir los avisos de seguridad e instrucciones puede resultar en daños a la propiedad, lesiones graves o la muerte

INFORMACIÓN GENERAL DE REMADO

Este manual ha sido compilado para ayudarle a operar su tabla inflable de Surf de Remo (en lo sucesivo ISUP) con seguridad y placer. Contiene detalles de la PU-RDSI, los equipos suministrados e información sobre su funcionamiento. Léalo detenidamente y familiarícese con la PU-RDSI antes de usarlo.

SEGURIDAD

Existe el riesgo de lesiones graves o la muerte por ahogamiento. Los deportes de remo pueden ser muy peligrosos y físicamente exigentes. El usuario de este producto reconoce, entiende y asume los riesgos involucrados en los deportes de remo. Siga las siguientes etiquetas de advertencia y estándares de seguridad cuidadosamente cuando usa este producto.



aquamarina.com

INSTRUCCIONES DE ETIQUETA DE ADVERTENCIA



INSTRUCCIONES OBLIGATORIAS

- Use un dispositivo de flotación personal
- Lea primero las instrucciones
- Infle completamente todas las cámaras de aire
- Número de usuarios
- Max. capacidad de carga
- Distancia segura a la orilla 150 m (492.1')



INSTRUCCIONES DE PROHIBICIÓN

- No lo use en aguas blancas (excepto BT-20RP)
- No usar en olas rompientes (excepto BT-20WA)
- No lo use en corrientes en alta mar
- No usar en viento de alta mar
- No apto para niños de 14 años o menores (excepto BT-19VIP)



ATENCIÓN / PELIGRO / ADVERTENCIA

- Diseño presión de trabajo
- Sin protección contra ahogamiento



INSTRUCCIONES OBLIGATORIAS

- Sólo nadadores
- Supervise siempre a los niños en el agua





CN-ORP







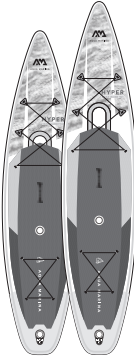
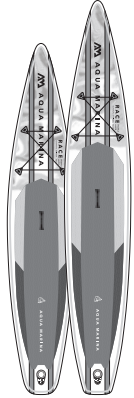

Item No.:

Oriental Recreational Products (Shanghai) Co., Ltd.
1699 Daye Road, Fengxian Shanghai, China 201402

NÚMERO DE SERIE DEL PROD

- No. Artículo
- Información del fabricante

ALREDEDOR								DE PASEO		DE CARRERA		DE RÍO
												
MODELO												
BREEZE	VAPOR	FUSION	MONSTER	CORAL	BEAST	MAGMA	ATLAS	HYPER	HYPER	RACE	RACE	RAPID
BT-21BRP	BT-21VAP	BT-21FUP	BT-21MOP	BT-21COP	BT-21BEP	BT-21MAP	BT-21ATP	BT-21HY01	BT-21HY02	BT-21RA01	BT-21RA02	BT-20RP
TALLA												
9'10"	10'4"	10'10"	12'0"	10'2"	10'6"	11'2"	12'0"	11'6"	12'6"	12'6"	14'0"	9'6"
30"	31"	32"	33"	31"	32"	33"	34"	31"	32"	27"	27"	33"
4.7"	6"	6"	6"	4.7"	6"	6"	6"	6"	6"	6"	6"	6"
300 cm	315 cm	330 cm	366 cm	310 cm	320 cm	340 cm	366 cm	350 cm	381 cm	381 cm	427 cm	289 cm
76 cm	79 cm	81 cm	84 cm	78 cm	81 cm	84 cm	86 cm	79 cm	81 cm	69 cm	69 cm	84 cm
12 cm	15 cm	15 cm	15 cm	12 cm	15 cm	15 cm	15 cm	15 cm	15 cm	15 cm	15 cm	15 cm
ALETA												
1 ALETA CENTRAL				1 ALETA CENTRAL				1 ALETA DE CARRERA		1 ALETA DE CARRERA		1 ALETA DE RÍO + 4 ALETAS FIJAS
VOLUMEN												
220 L	310L	320L	380L	230L	300L	330L	390L	330L	370L	320L	360L	300L
PESO MÁXIMO DEL RIDER												
220 LBS	308LBS	330LBS	374LBS	231LBS	308LBS	330LBS	396LBS	330LBS	374LBS	330LBS	352LBS	286LBS
100 KG	140KG	150KG	170KG	105KG	140KG	150KG	180KG	150KG	170KG	150KG	160KG	130KG
PRESIÓN MÁXIMA DE AIRE												
15 PSI				15 PSI				15 PSI / 10 PSI (cámara central)		18 PSI		18 PSI

SURF	WINDSURF	MULTIPERSONA				APTITUD FÍSICA		PESCA	NIÑOS
						Yoga Dock BT-19YD Diámetro externo: 290cm/9'6" Diámetro interno: 170cm/67" Grueso: 12cm/4.7" 			
WAVE BT-20WA	BLADE BT-20BL	SUPER TRIP BT-21ST01	SUPER TRIP TANDEM BT-20ST02	MEGA BT-20ME	AIRSHIP RACE BT-20AS	PEACE BT-20PC	DHYANA BT-21DHP	DRIFT BT-20DRP	VIBRANT BT-19VIP
8'8" 30" 4"	10'6" 33" 4.7"	12'2" 32" 6"	14'0" 34" 6"	18'1" 60" 8"	22'0" 34" 8"	8'2" 35" 6"	11'0" 36" 6"	10'10" 38" 6"	8'0" 28" 4"
265 cm 75 cm 10 cm	320 cm 84 cm 12 cm	370 cm 82 cm 15 cm	427 cm 86 cm 15 cm	550 cm 152 cm 20 cm	670 cm 87 cm 20 cm	250 cm 90 cm 15 cm	336 cm 91 cm 15 cm	330 cm 97 cm 15 cm	244 cm 71 cm 10 cm
1 ALETA CENTRAL	1 ALETA TIPO DAGA + 1 ALETA CENTRAL	1 ALETA CENTRAL	2 ALETA CENTRAL	5 ALETA CENTRAL	1 ALETA DE CARRERA	/	1 ALETA CENTRAL	1 ALETA CENTRAL	1 ALETA CENTRAL
165L	280L	400L	500L	1400L	1000L	340L	360L	284L	140L
209LBS 95KG	264LBS 120KG	462LBS 210KG	507LBS 230KG	1433LBS 650KG	1014LBS 460KG	330LBS 150KG	352LBS 160KG	286LBS 130KG	132LBS 60KG
18 PSI	18 PSI	15 PSI	18 PSI	8 PSI	18 PSI	15 PSI		15 PSI (tabla) / 3PSI (cámaras laterales de aire)	15 PSI

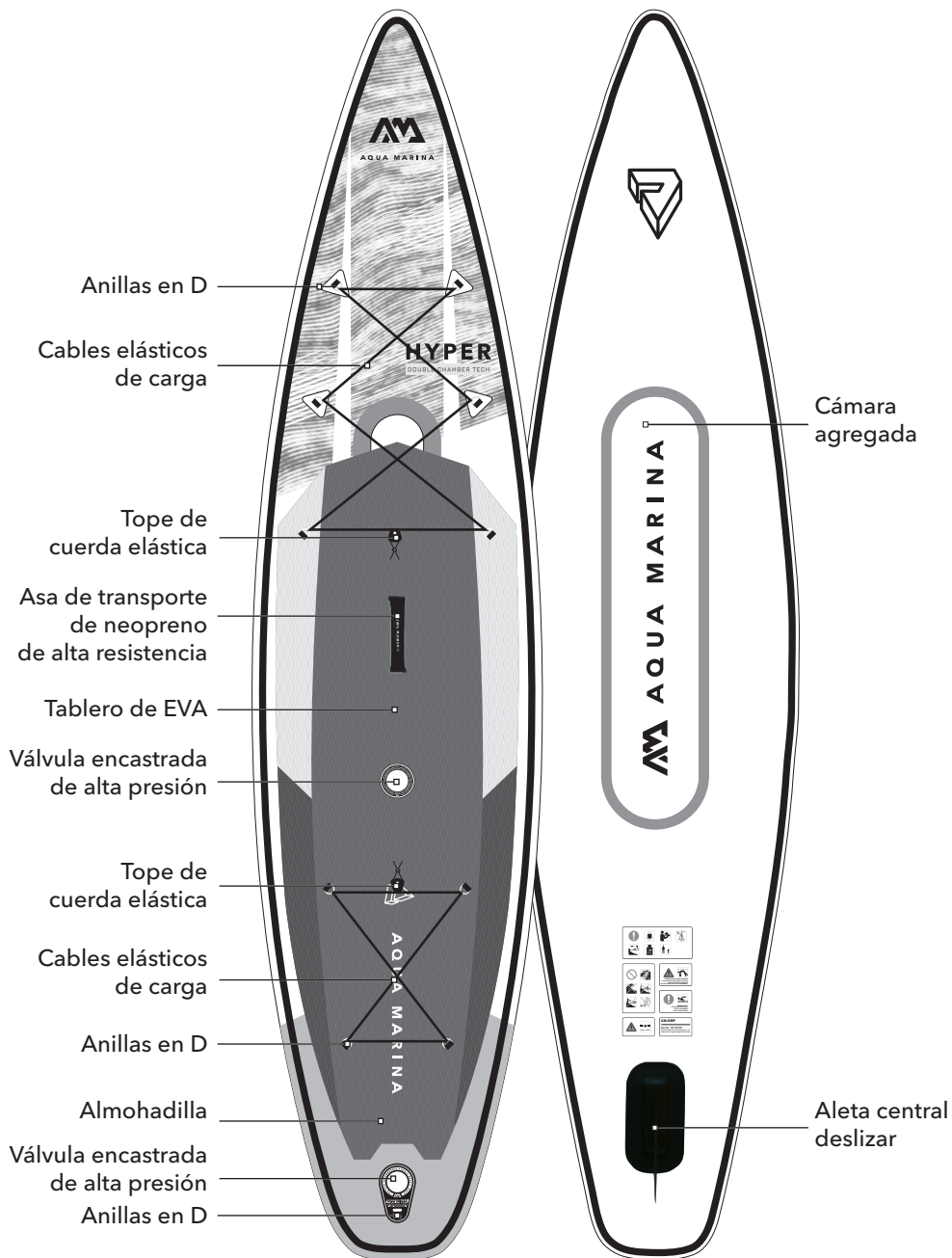

La configuración real puede variar según los modelos.

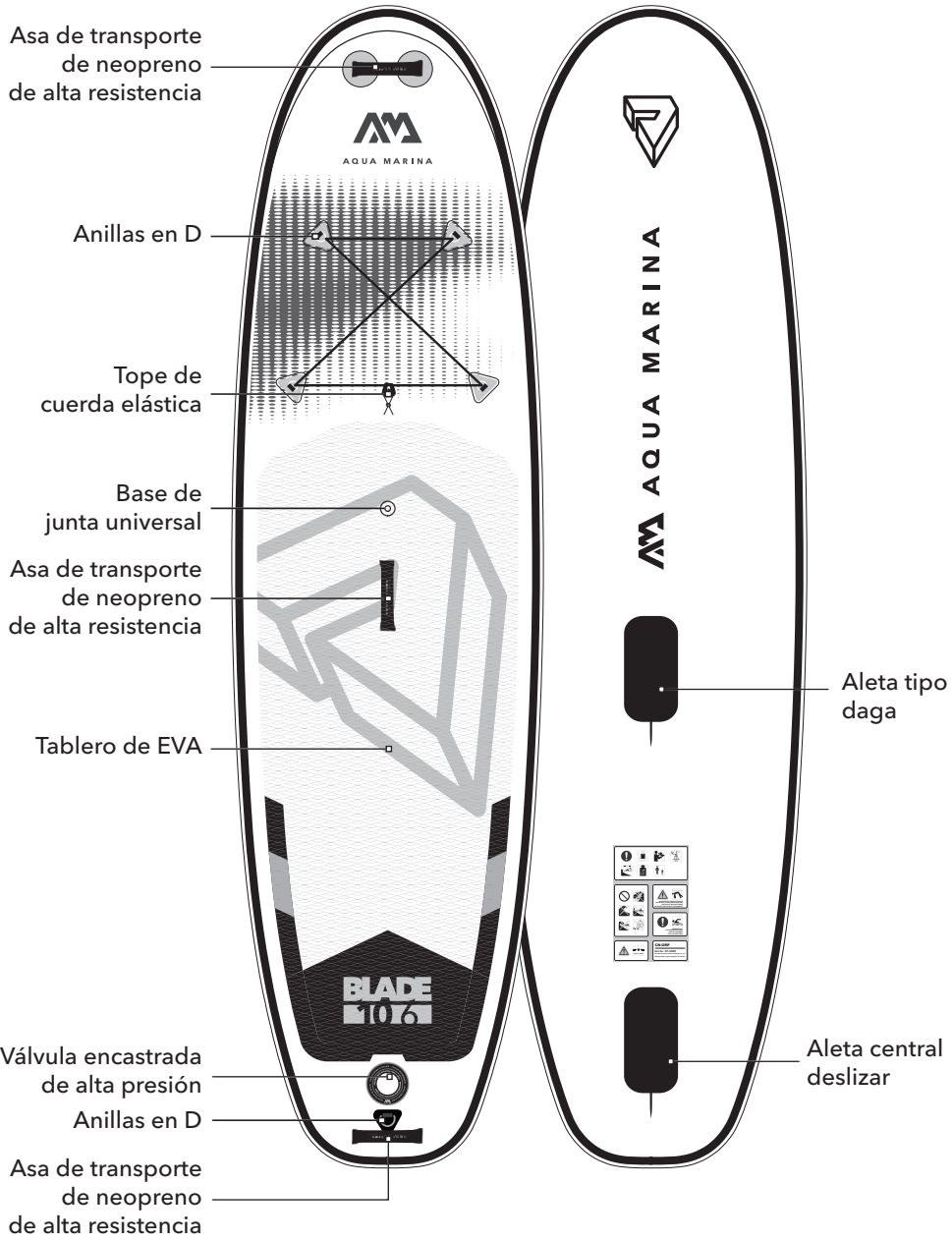

La configuración real puede variar según los modelos.

ACCESSORIES

STANDARD

Mochila de cierre

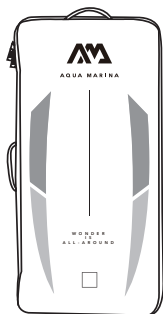

Bomba de doble acción -
LIQUID AIR V1

(Mega/Airship Race/ Super Trip Tandem x 2)
(Coral/Beast/Magma/Atlas/Hyper/Race
vienen con LIQUID AIR V2)

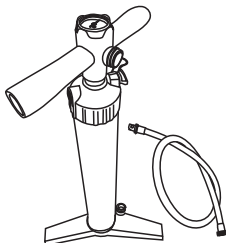

Aleta central

(Mega x 5 /
Super Trip Tandem x 2)



Cables elásticos
de carga

(excepto Wave) (Hyper x 2)



Kit de reparación



Correa

(excepto Super Trip/ Super Trip Tandem/Mega/
Airship Race/Peace/Yoga Dock)

DRIIFT

Soporte caña de pescar
x 2

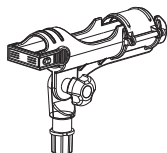

Soporte de remo

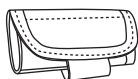

MEGA/YOGA DOCK

Bolsa de transporte

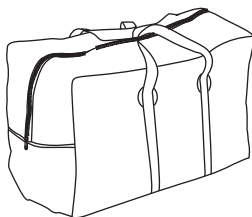

CORAL/YOGA

Tira de tabla



Soporte de remo
(Solo para Dhyana)

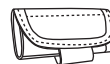

Tiras x 3
(Solo para Dhyana)

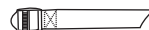

PALETA

PALETA (excepto Race/Hyper/Rapid/Super Trip/Mega/Airship Race/Blade/
Wave/Peace/Super Trip Tandem)

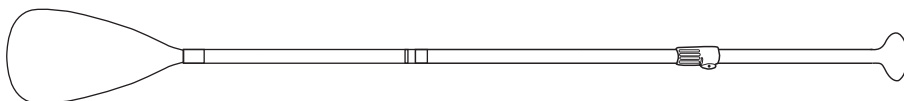

INSTRUCCIONES DE MONTAJE Y DESMONTAJE

A

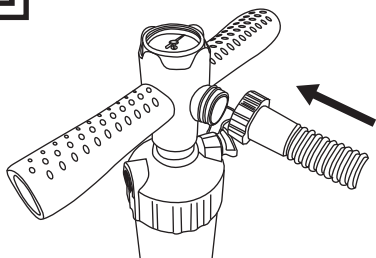

Ajuste e Inflado de la bomba

Conecte la manguera de la bomba a la carcasa y asegúrela firmemente.

B

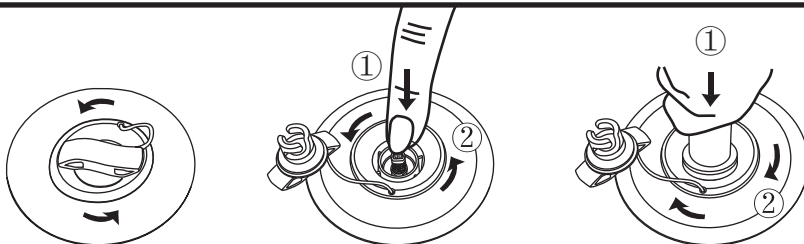

1. Suelte la tapa de la válvula girándola en sentido antihorario. Asegúrese de que la válvula no tenga restos de arena o suciedad antes de soltarla.
2. Presione el botón de la válvula hacia adentro y gírelo en sentido contrario a las agujas "OUT" del reloj 90 grados para que salte y esté en la posición.
3. Inserte la manguera de la bomba y gírela 45 grados en el sentido de las agujas del reloj para asegurarla en su lugar. Inflar hasta alcanzar la presión requerida.



12PSI mínimo (8PSI para MEGA / 10PSI para la cámara interior HYPER) para inflado adecuado de tablas y 15PSI máximo de operación (18PSI para SUPER TRIP TANDEM / RAPID / RACE / WAVE / BLADE / AIRSHIP RACE). Inflar demasiado anula su garantía.

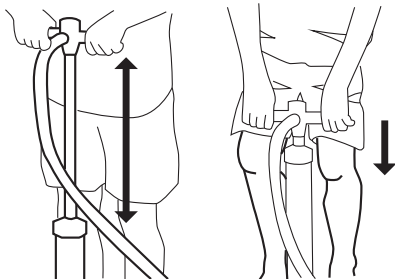

Inflar más rápido con menos esfuerzo

- Use el rango completo del cilindro de la bomba mientras mantiene sus brazos extendidos.
- Doble las rodillas y use el peso corporal.

C

LIQUID AIR V1

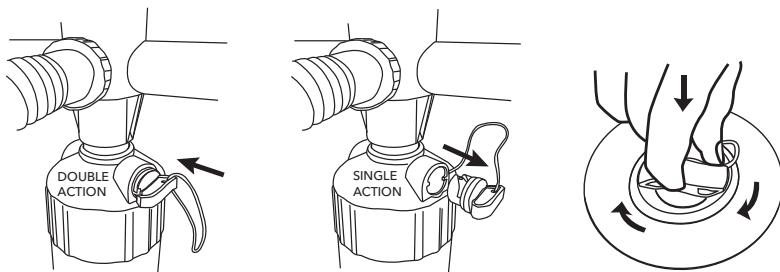

1. Utilice el modo de **ACCIÓN DOBLE** cerrando la llave de aire para bombear la tabla hasta 7 psi.
2. Cambie a la posición de **ACCIÓN ÚNICA** abriendo la toma de aire para bombear la tabla hasta 15 - 18 psi.

LIQUID AIR V2

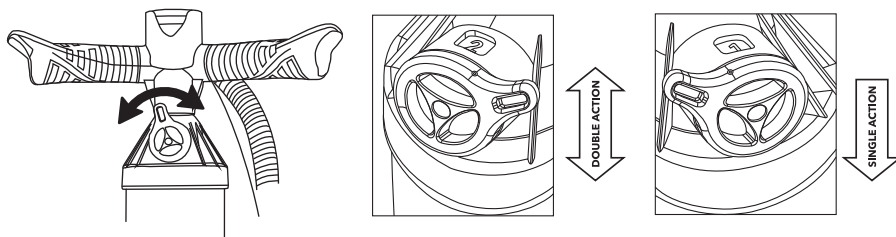

1. Use el modo **DOBLE ACCIÓN** con la tapa superior mostrando "2" para bombear la tabla hasta 7 - 10 psi.
2. Gire el interruptor de modo **ACCIÓN ÚNICA** con la tapa superior mostrando "1" para bombear la tabla hasta 15 - 18 psi.

Después del inflado, vuelva a colocar la tapa de la válvula y apriétela en el sentido de las agujas del reloj para fijarla en su sitio.

Precaución y Consejo

- Las bombas eléctricas se pueden usar para inflar la tabla hasta un 80-90%. sin embargo, la presión remanente requerida debe lograrse usando la bomba de mano para evitar el inflado excesivo.
- No use compresores de aire ya que esto anula la garantía de la tabla.
- Antes de realizar viajes largos, asegúrese de que la tabla se haya inflado y haya mantenido la presión durante un mínimo de 24 horas.

10psi



15psi



Para tabla de doble cámara

Para obtener el mejor rendimiento, la cámara doble siempre debe estar inflada para garantizar la mayor rigidez y seguridad.

- Infle la cámara interior hasta 10 PSI.
- Infle la cámara exterior hasta 15 PSI.

D

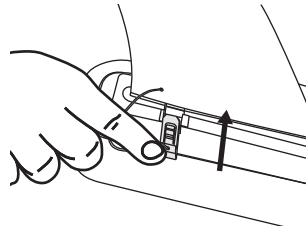
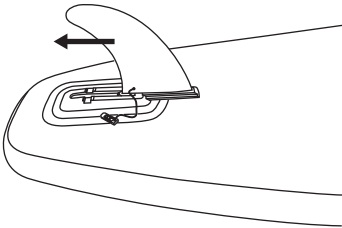

Instalación de aleta central deslizante

Una vez que la tabla está inflada, deslice la aleta central grande hacia la base de la aleta e inserte la clavija de inserción.

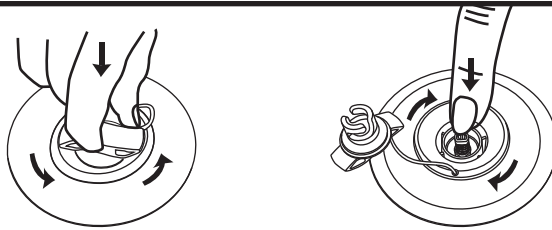
E

Desinflado

Para desinflar su tablero, siga las instrucciones a continuación.

1. Suelte la tapa de la válvula girándola en el sentido contrario a las agujas del reloj. Asegúrese de que la válvula esté sin restos de arena o suciedad antes de soltarla.
2. Presione el botón de la válvula hacia adentro y gírelo en el sentido de las agujas del reloj para bloquearlo en la posición ABAJO.

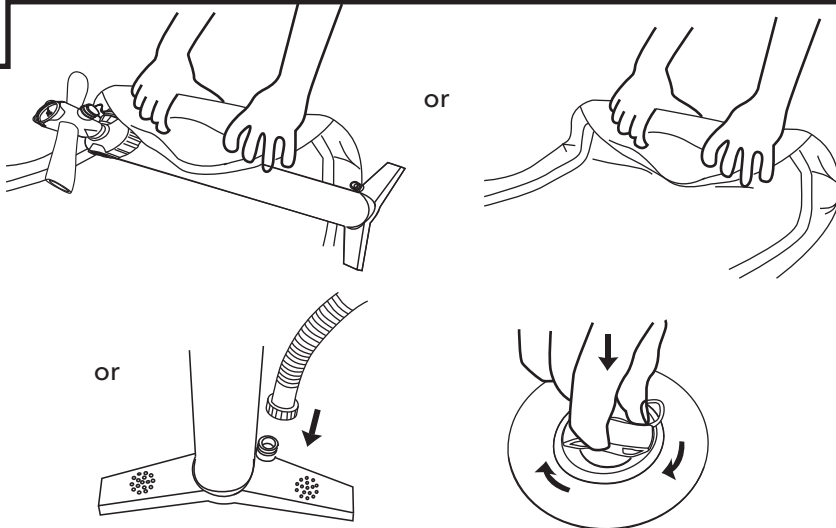
F

Pasos de Plegado

1. Recomendamos enrollar la tabla alrededor de la bomba y sacar todo el aire mientras la enrolla. También puede enrollar la tabla desde la parte anterior a la posterior sacando todo el aire mientras la enrolla, o usar la bomba en la posición "desinflar" (solo para LIQUID AIR V1) para desinflar más rápido.
2. Presione todo el aire fuera de la tabla, devuelva la cubierta de la válvula, y apriete en el sentido de las agujas del reloj para bloquear en su lugar.

NOTA:

Para la table RACE, recomendamos enrollar la tabla alrededor de la bomba. También puede plegar por la línea de puntos como se muestra a continuación (Imagen A) para evitar plegar las almohadillas laterales.

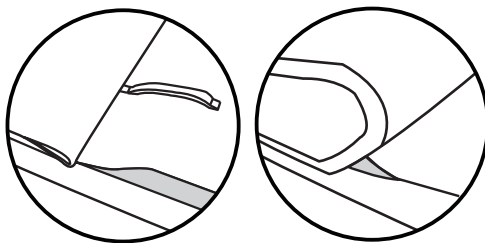

TIP:

Comience a doblar desde aquí.

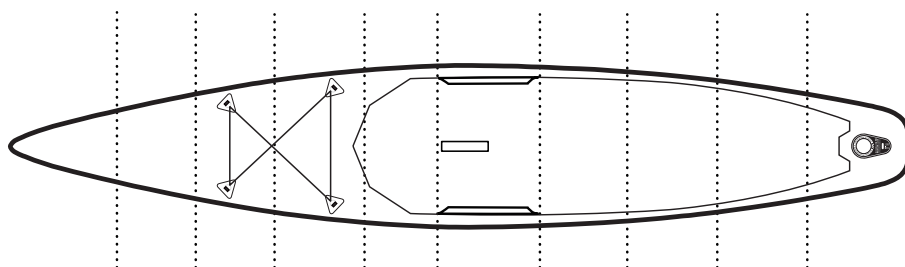
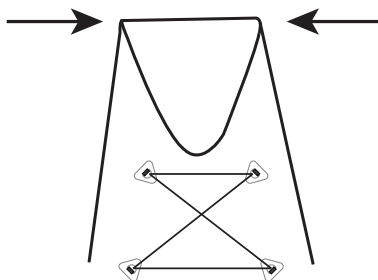

(Imagen A)

CÓMO REPARAR UN CORTE O PERFORACIÓN EN LA TABLA

G

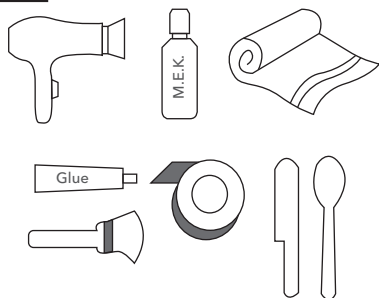

Suministros Requeridos

- Pegamento (AQUASEAL® recomendado)
 - Acetona o metiletilcetona
 - Secador de pelo
 - Cepillo
 - Cinta
 - Espátula o cuchara
 - Toalla
- (No se proporciona en el paquete de la placa SUP)



1

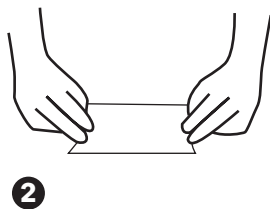

2

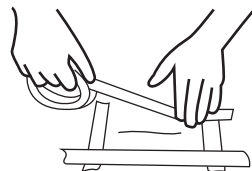

3

1. Limpie el área alrededor del corte o pinche con acetona o M.E.K
2. Dibuje el contorno del parche con tiza o lápiz (no use tinta). Corte el parche, cubra el corte o pinche con una superposición de aproximadamente 2,5 cm (1 pulgada) en todos los lados.
3. Coloque cinta a lo largo del contorno del parche. Esto evitará que el pegamento se extienda fuera del área del parche.

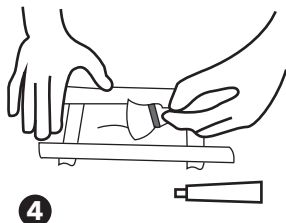

4

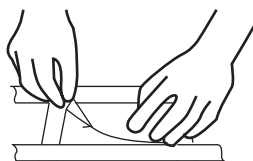

5

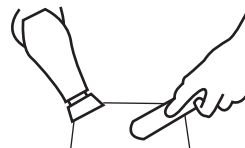

6

4. Aplique pegamento tanto en la pizarra como en el parche con un cepillo u otro aplicador. Asegúrese de que el pegamento se extienda uniforme y completamente sobre la tabla y el parche. Deje que el pegamento se seque durante 5 minutos.

5. Coloque el parche empezando por un lado y moviéndose hacia el otro lado teniendo cuidado de no atrapar burbujas de aire.
6. Use un secador de pelo para calentar suavemente el área para asegurar una buena unión entre el parche y la tabla. Use una espátula o cuchara de metal y presione firmemente para asegurar una buena unión y para eliminar cualquier burbuja de aire.

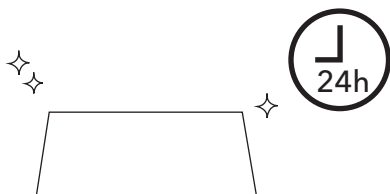

Deje que el pegamento se seque con la placa sin inflar durante 24 horas antes de su uso.

CÓMO ARREGLAR UNA VÁLVULA CON FUGA

H

A. Apriete la válvula

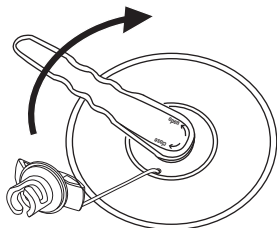

1. Infle la tabla hasta la presión máxima de aire
2. Apriete la llave de la válvula dentro de la válvula y gire a la derecha para apretar la válvula dentro de la tabla

B. Reinstale o reemplace la válvula

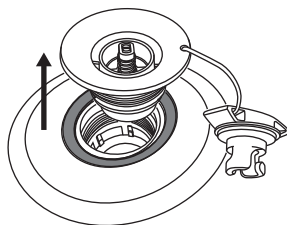
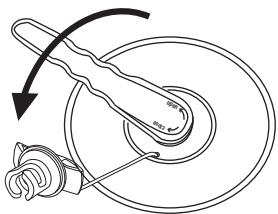

1. Desinfe completamente su tabla
2. Quite el tapón de polvo e inserte la llave de la válvula dentro de la válvula y gire a la izquierda para retirar la válvula.



3. Compruebe el anillo de goma para asegurarse de que está en la posición correcta, apriete alrededor de la válvula y asegúrese de que no haya residuos en medio
4. Asegúrese de que el pasador elástico funciona correctamente y que no haya grietas por los bordes

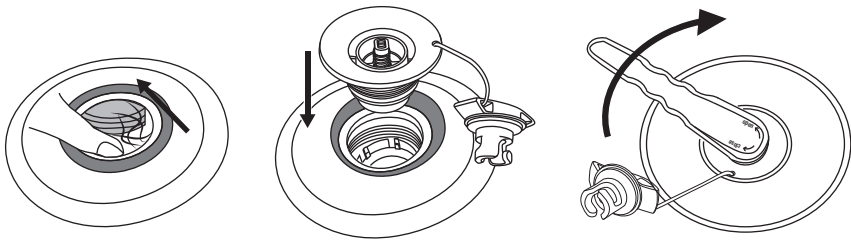

5. Asegúrese de que no haya puntadas sueltas del material cosido
6. Tenga en cuenta que la pieza inferior de la válvula no va sujeta a nada
7. Coloque la válvula de nuevo en la tabla
8. Alinee todas las roscas y gire para apretar
9. Una vez que la válvula se aprieta con la mano, use la llave de la válvula para sellar completamente



NOTA: Use correctamente la llave presionándola con una mano en la parte superior.

MONTAJE DE LA TABLA

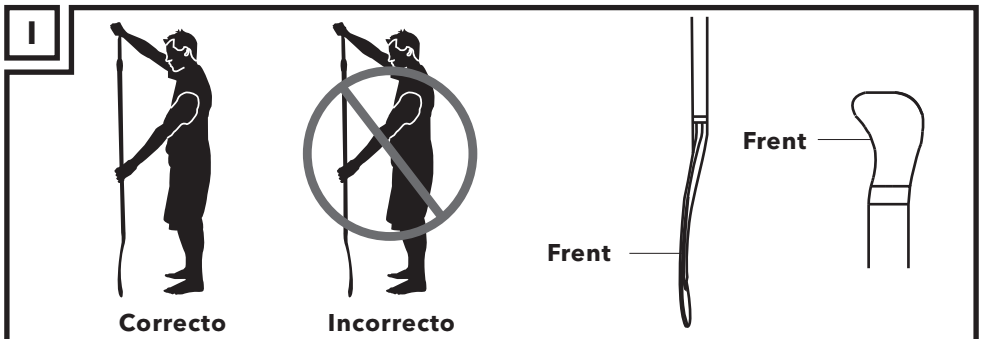

El eje ajustable Aqua Marina de 3 piezas utiliza un sistema seguro de pasador elástico y viene con una abrazadera adicional para reducir cualquier movimiento.

PASADOR DE SEGURIDAD

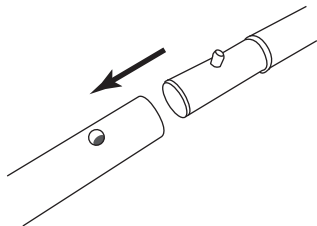

ABRAZADERA PARA EJE DE ALUMINIO

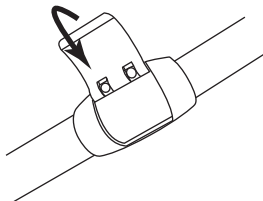

ABRAZADERA PARA EJES CARBONO Y FIBRA DE VIDRIO CLAMP

Ajuste fácilmente el nivel de ajuste girando el cierre para evitar cualquier movimiento.

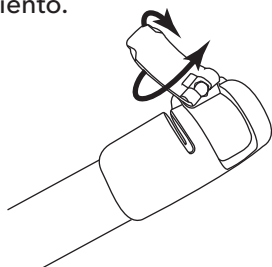

Asegúrese de que la línea central de la escala esté alineada con el indicador de la abrazadera

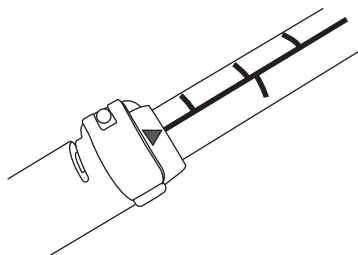

NOTA: Drene siempre el agua que quede en el eje de la paleta tras cada uso.

3 UDS AJUSTABLES

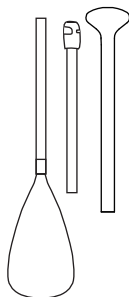

- **SPORTS III** B0303012
iSUP Tabla ajustable de aluminio
- **SOLID** B0303013
Tabla ajustable de Fibra iSUP
- **CARBON GUIDE** B0303014
Tabla carbono/fibra de vidrio
- **CARBON PRO** B0303015
Tabla iSUP de carbono

2 UDS AJUSTABLES

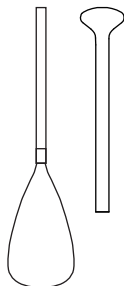

- **CARBON X** B0303016
Pala de dos secciones de Carbono iSUP

2 EN 1

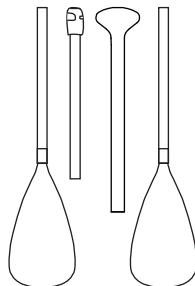

- **DUAL-TECH** B0303011
2-en-1 iSUP y Tabla de Kayak

CÓMO LLEVAR UNA CORREA DE SEGURIDAD

CINTURA



CORREA FLUVIAL
B0303025

TOBILLO



CORREA DE ROLLO
B0303023



CORREA SE SURF
B0303024



CORREA ESTÁNDAR
B0302765

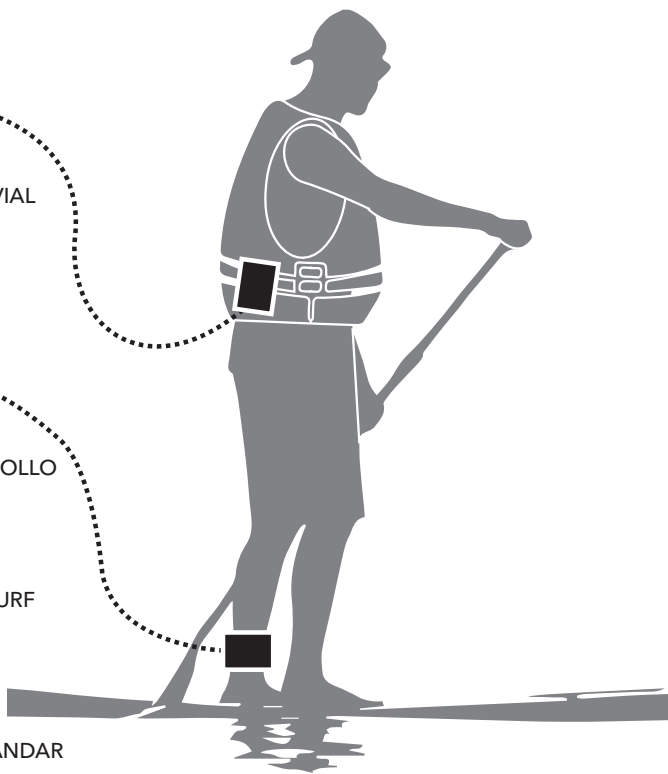

INSTALACIÓN DE CORREA ESTÁNDAR

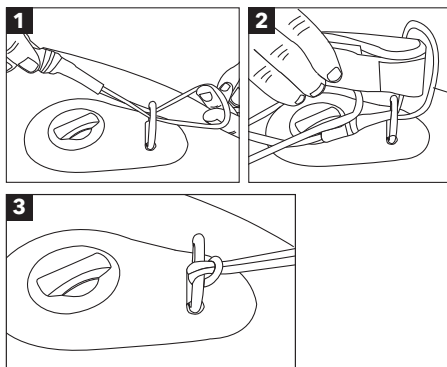

INSTALACIÓN DE CORREA DE ROLLO/ SURF/ FLUVIAL

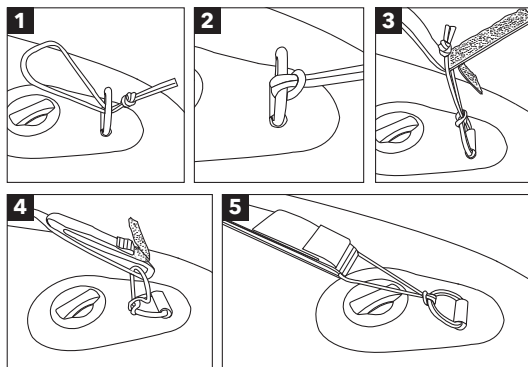

Preguntas Frecuentes

Q: ¿Cuánto aire debería bombear en la tabla, y cuánto tiempo tarda en inflarse?

A: La presión recomendada es de 15 a 18 PSI (8PSI para MEGA, 10PSI para la cámara interior HYPER) , cualquier inflado superior supone riesgo de daños. Dependiendo del tamaño de su tabla, puede tomar de 5 a 8 minutos.

Q: Al separar la bomba de la placa, el aire comienza a salir de la válvula. ¿Cómo evito que esto suceda?

A: El aire se está liberando ya que el pasador de resorte de la válvula se ha dejado en la posición de desinflado. Simplemente presione hacia abajo y gire el pasador hasta que se levante en la posición de inflado y evite que salga el aire; continúe inflando la tabla.

Q: ¿Puedo dejar mi tabla inflada al sol y durante la noche?

A: Si deja la tabla inflada, le recomendamos encarecidamente que la quite de la luz solar directa y desinfe la tabla al menos hasta 10PSI (5PSI para MEGA).

Q: ¿Cómo debo limpiar y cómo debo guardar mi tabla?

A: Solo recomendamos agua y un jabón suave. Los detergentes y solventes fuertes pueden dañar su tabla. Lo mejor es limpiar y secar la tabla, sacar las aletas, enrollarlo y ponerlo en la bolsa.

Q: Si pincho mi tabla, ¿puedo repararlo solo?

A: Sí, puede usar las herramientas requeridas mencionadas en el manual con el kit de reparación suministrado o enviarnos un correo electrónico para obtener más información a info@aquamarina.com.

GARANTÍA

1
AÑO

AM garantiza que este producto está libre de defectos importantes en el material o su fabricación al comprador original por un período de un (1) año a partir de la fecha de compra. Esta garantía está sujeta a las siguientes limitaciones

1. La garantía es válida solo cuando este producto se usa para actividades recreativas normales y no cubre los productos utilizados para alquiler o excursiones escolares.
2. AM tomará la determinación final de la garantía, lo que puede requerir la inspección y/o fotos del equipo, que muestren claramente el (los) defecto (s). Si es necesario, esta información debe enviarse al distribuidor de AM en su país con franqueo prepago. El producto puede devolverse solo si el distribuidor de AM proporciona un número de autorización de devolución por adelantado. El número de autorización de devolución debe estar claramente etiquetado en el exterior del paquete, o será rechazado.
3. Si AM considera que un producto es defectuoso, la garantía solamente cubre la reparación o el reemplazo del producto defectuoso. AM no será responsable de ningún costo, pérdida o daño incurrido como resultado de la pérdida o mal uso de este producto.
4. Esta garantía no cubre daños causados por uso indebido, abuso, negligencia, desgaste normal incluyendo, entre otros, punciones, daños por exposición excesiva al calor, daños causados por manipulación y almacenamiento incorrectos, daños causados por el uso en olas o en la costa con rompimiento de olas, rotura de la tabla causada por el llenado o el derrumbamiento en condiciones de oleaje, o daños causados por cualquier cosa que no sean defectos en materiales y mano de obra.
5. Este producto no debe ser modificado y/o equipado con un motor, excepto la aleta de potencia AM BlueDrive.
6. Este producto no debe usarse superando la capacidad de carga máxima recomendada por los fabricantes.
7. Esta garantía quedará anulada si se realiza alguna reparación, cambio o modificación no autorizada en cualquier parte del equipo.
8. La garantía de cualquier equipo reparado o reemplazado es válida solamente desde la fecha de la compra original.
9. El recibo de compra original debe acompañar todos los reclamos de garantía. El nombre del minorista y la fecha de compra deben ser claros y legibles.
10. No hay garantías que se extiendan más allá de la garantía especificada aquí.



ADVERTENCIA

Este producto está diseñado de acuerdo con las normas para un uso específico. Cualquier modificación o transformación superior a la indicada por el fabricante podría generar riesgos graves para el usuario y anulará la garantía.